

23.24

**ELEVATE
YOUR SENSATIONS**

CONTACTS

BAPTISTE BARBOT
International Sale Manager
baptiste@zagskis.com
+33 669 627 912

MARINE TESTOU
Events Manager
events@zagskis.com
+33 787 805 907

THOMAS CHABOT
Pros Supervisor
pro@zagskis.com
+33 7 85 80 22 36

SUMMARY

01.

ZAG UNIVERSE 04

02.

ZAGREEN PROGRAM 10

03.

ADRET 18

04.

UBAC 25

05.

HARFANG 34

06.

SLAP 42

07.

ACCESSORIES 52

08.

CONTACTS 60

ICONIC BRAND

Zag, located in Chamonix, has become a brand of reference in the all mountain, freeride and touring ski industries. A bold and enthusiastic team remains on the cutting edge of research with the goal of designing increasingly intuitive and high-performing skis.

Today, this high-end brand holds close its values of passion and authenticity, continuing to anticipate the evolving demands of the ski market. Certain skis have become emblematic- like the UBAC for tourers or SLAP for free-tourers without limit. Known for its technical precision and its strong visual identity, ZAG remains the brand of choice for mountain lovers looking for unique slide sensations.

For this new 23.24 season, we've completely redesigned our best-seller range, the UBAC. We are not allowed to fail. The design is strong and we are confident about it. We are bringing modernity and technology to this range, that is sometimes too clean !

And the new 92 under foot width from our SLAP range will allow skiers that are looking for sensations on the slopes to really enjoy the pleasure of carving. »

You are welcome in our office and Lab in Chamonix all winter long to discuss with us.»

Caroline de Wailly, CEO



INNOVATIVE DESIGN

Saint-Lazare, formerly Be-Poles, was born at the beginning of the 2000's and developed in Paris and New York with the aim of : building strong and long-lasting brands, based on strong basis and not on passing fads. We often introduce ourselves as a designs studio rather than as an agency. Creation, guided by our intuition, is at the core of our approach.

We always wanted to think about the brand not as a logo but as stories to live and memories to create. Our job consists of understanding and telling a brand's story with sensitivity, intelligence and experience to allow it to be understood. To conclude, our narrative approach will serve their brand's speech.

Meeting ZAG was the perfect opportunity to combine this approach with the brands and our enthusiasm for mountains. Antoine Ricardou, co-founder of the Studio with Clémentine Larroumet has fasteners is La Clusaz in the Aravis (Alps). Every winter he roams the mountaintops and alpine tracks on his UBAC. This confrontation with ZAG's reality reinforces each year his graphic proposal for the lines he's constantly renewing.

« For the 23.24 collection, ZAG is still focusing on colour and typography. Using colours in stark contrast with the snow's white such as fluorescent or metallic colours is the baseline of the brand. Following these rules, the colours are evolving from seasons to seasons. This year we also dug inspiration from the geometric work from Marcel Floris and Yusula Kamekura.»

Antoine Ricardou,
SAINT-LAZARE, Paris - NY, Founder & Designer

SAINT-LAZARE
PARIS — NEW YORK

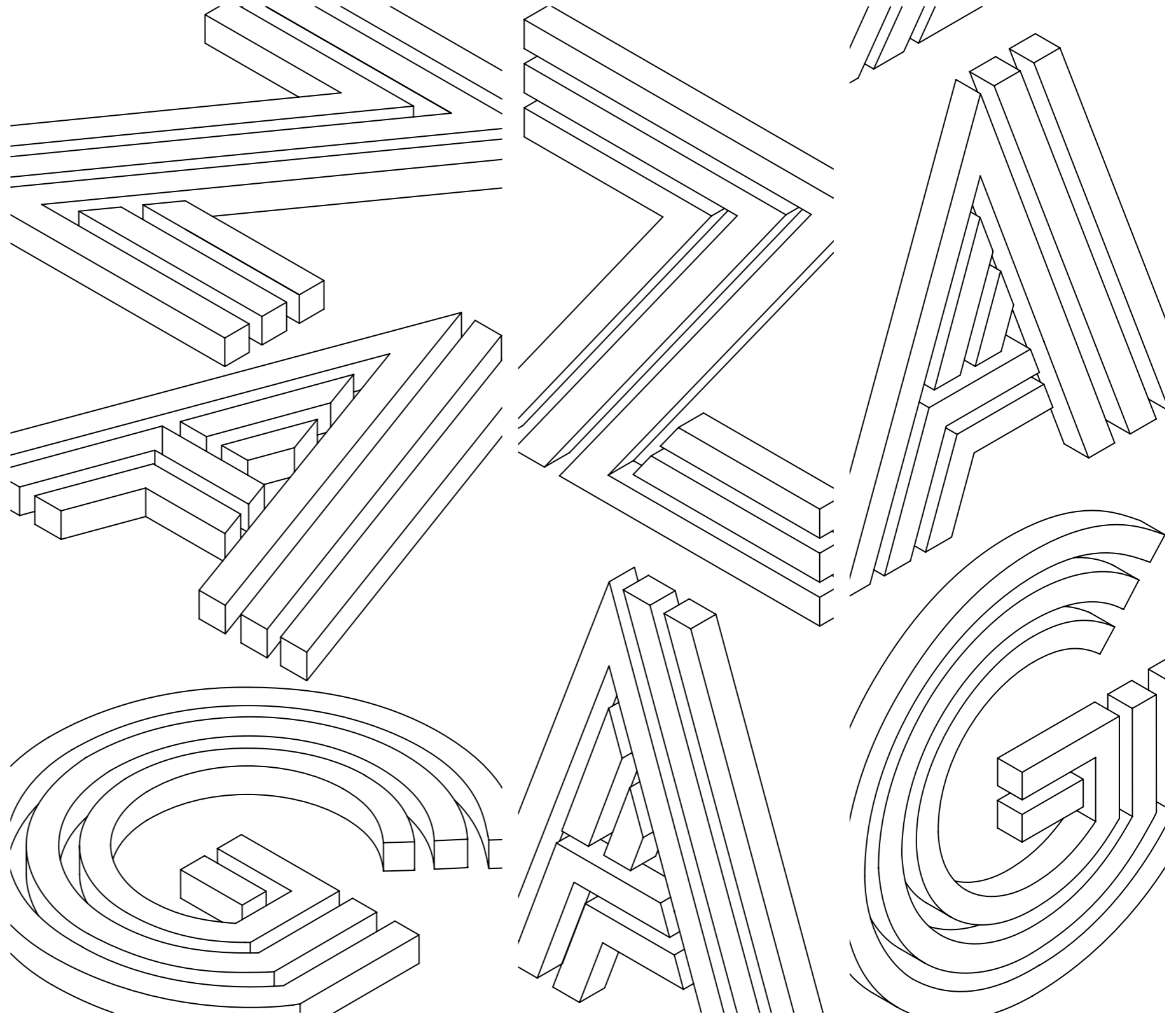

ADVANCED TECHNOLOGY

Our two engineers Bastien Saillard and Paul Chevalot design our skis in the ZAG Lab located in Chamonix with the goal of satisfying the many tastes of our customers. Always hungry to improve, they spend their time studying innovative shapes, materials, and constructions.

“We are compelled to endlessly innovate by creating skis that are increasingly intuitive, comfortable, high performing, and that provide skiers with a unique riding experience. With our concept store at the foot of Grands Montets, our playground is in our backyard. Being so connected with the environment is a true source of inspiration. This is what allows us to create such comfortable and high-performing skis.”
Bastien Saillard, Director of Research and Development

The ZAG LAB allows our engineers to create prototypes in record time, and its prime location in Chamonix lets us test them right away and make improvements accordingly. The team was able to test the skis on all types of snow. They developed a new SLAP 92, a new playful on-piste ski that allows unique carving sensations.

This connection to nature pushes ZAG’s R&D team to create products that are respectful to the environment, especially through the use of new materials or designs. The ZAGREEN Program represents ZAG’s commitment to sustainability.

ZAG LAB
INSIDE OUR WORKSHOP

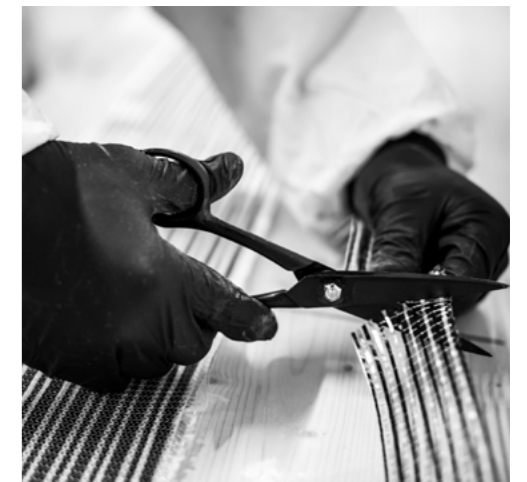
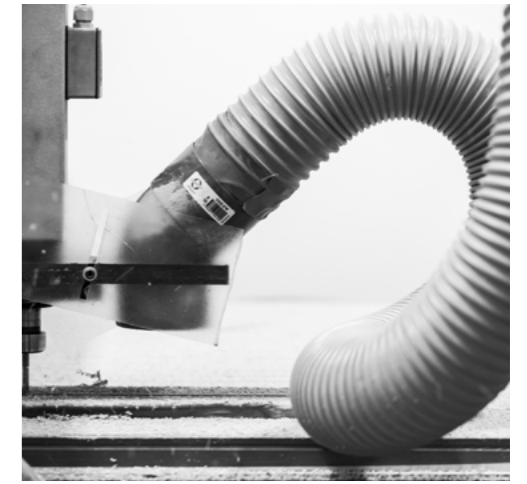



ZAGREEN PROGRAM

Aware that our playground is threatened and that the quality of the air in the valley is more and more an issue of discussion, ZAG has launched the ZAGreen Program. Created in 2017, the aim of this program is to reduce the environmental impact of the ski industry. The actions that will be done will concern the manufacturing of the products, the way we practice skiing and also the daily life in our office. In addition to the measures involving only the company, the aim is to increase awareness among the whole community about the environmental challenge that is the air quality in our valley. ZAGreen is a project that hopes to be heard and also to involve more actors of this beautiful place.

This program's emblem is the snowy owl. This huge white bird conveys the idea of pure natural areas that are the playground of the brand. ZAG associates its brand to this rare and protected bird to achieve its eco-friendly project.

The enrolment of the ski-touring line in the project 1% for the planet also helps ZAG reaching its goal : preserving its playground. In 2021, ZAG redistributed this percentage to Mountain Wilderness. In 2022, we are giving the 1% to Mountain Riders and the cleaning project «Adopt ton spot».



BIO SOURCED RESIN

We have used a resin which is 33% bio-sourced to produce the models ADRETS since 2016. It is mainly composed of oil produced with oil plants.



MATERIALS FROM EUROPE

Constant research to find the most performing and eco-responsible materials.

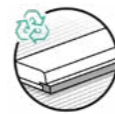

RECYCLED EDGES

Thick edges on alpine skis on thin edges on ultra-light skis. The edges are from recycled metal.



WOODEN CORE

Quality gain. Ensures the durability. Respects the forests sustainable management.



**EXPLORE
MORE
DESTROY
LESS**

GOLETTA 2023/24



CONSTRUCTIONS

EXTRA LIGHT ADRET

The combination to procure lightness and comfort, while having a rigid construction at the same time in torsion and flexion, with exemplary reliability. The perfect mechanical characteristics for ski touring! This construction is therefore for the touring line. High modulus and high resistance carbon fibers give the skis the lightness and rigidity expected by the demanding hikers. Kevlar fibers absorb vibrations to give an impeccable touch of snow, on the hard or in the powder.

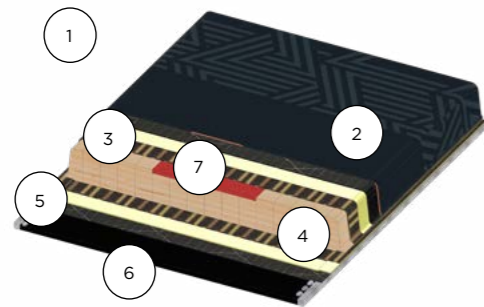

LIGHT UBAC

One goal: to allow skiers to have a light and comfortable ski in all types of snow. This result is achieved through the combination of glass and carbon fibers, making the Touring UBAC skis twice as stiff in torsion. The paulownia wood core allows you to fetch a few extra grams, without affecting the touch of snow and the resistance of the material. ABS sidewalls and high resistance steel edges help the ski to resist the impacts therefore to ski safely!

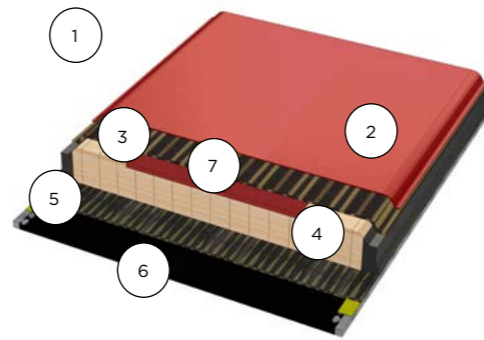

HEAVY DUTY HARFANG

The best compromise between stiffness in flexion and torsion. Composed of a double layer multi-axial fiberglass, the objective is to make skis effective in all types of snow. From the legendary H-112, having proven these to the feet of our best riders, the Heavy Duty construction gives skiers reliability and maximum safety. Lightweight, for more off-road flotation, but rigid, to fully enjoy days of trafole, this construction makes the ski catchy on hard snow so to link the curves!

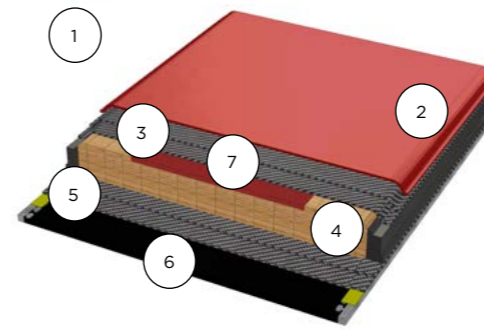

HEAVY DUTY LIGHT SLAP

Lightness and power to hit the slopes and the large fields of fresh snow. This construction uses multi-axial fiberglass, increasing the skiability and power by providing stiffness in torsion and flexion. The goal is also to reduce the final weight of these XXL skis, hence the presence of paulownia for 1 lightness, in addition to the poplar for resistance. In the end, 2 this construction makes skis light, playful, stable at high speed 3 and resistant in time that characterize the legendary SLAP's DNA.

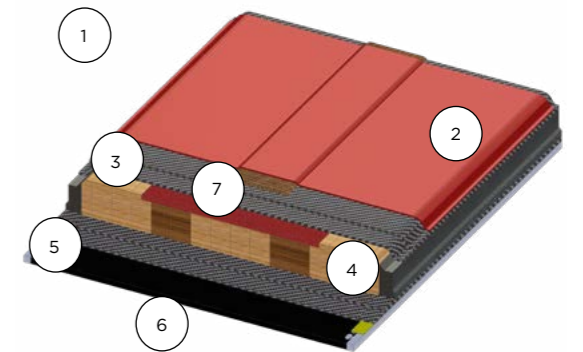

- 1 - 3D structure
- 2 - Polyamide topsheet
- 3 - Carbone/kevlar fibre
- 4 - Paulownia wood core
- 5 - High resitances edges
- 6 - Sintered bases
- 7 - Phenol sheet



- 1 - 3D structure
- 2 - Polyamide topsheet
- 3 - Carbone/kevlar fibre
- 4 - Paulownia wood core
- 5 - High resitances edges
- 6 - Sintered bases
- 7 - Phenol sheet



- 1 - 3D structure
- 2 - Polyamide topsheet
- 3 - Multi-axial fiber
- 4 - Poplar wood core
- 5 - High resitances edges
- 6 - Sintered bases
- 7 - Phenol sheet



- 1 - 3D structure
- 2 - Polyamide topsheet
- 3 - Multi-axial fiber
- 4 - Paulownia & Poplar wood core
- 5 - High resitances edges
- 6 - Sintered bases
- 7 - Phenol sheet

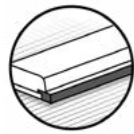

EDGES

The edges on all skis come from 100% recycled steel. Presenting the best hardness/strength compromise, these edges are highly shock resistant while avoiding breakage, especially off-piste.

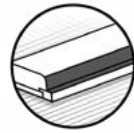

SIDEWALLS

The ABS sidewalls are present on the H, SLAP et UBAC ranges. They allow the skis to have increased durability and, because of their rigidity, a better transmission of the power on the edges.



TOPSHEET

In order to make the skis more resistant to repeated outings, ZAG skis are equipped with polyamide topsheet. This transparent and material allows to highlight the colors of the skis, while guaranteeing the highest impact and scratch resistance on the market.



REINFORCING PLATES

In order to guarantee optimal fastening performance, ZAG integrates, in the design of all its models, phenol reinforcements in which the bindings are anchored.



BASE

The sintered base, high molecular weight, present on all the models, have the advantage of being stronger and more resistant to shocks and abrasion than extruded base. This base also has better wax absorption capacity and provides better glide.



WOOD CORE

Essential part of the skis, providing both the soul and the skiability, the cores present in the skis are composed of different species of wood, poplar and paulownia, according to the desired characteristics for the skis.



STABILITY LINK - LINEN FIBER

Inserting flax fibres allows a maximum vibration absorption.



CAMBER

ZAG cambers' are adapted and calibrated according to each range to obtain the right behavior. It influences stability, grip and energy transfer.

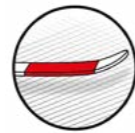

ROCKER

ZAG rockers' are long and progressive which allows an excellent lift off and a very good handling on all types of snow.

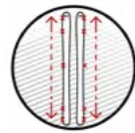

5 POINTS SHAPE

Specific shape technic that enables us to increase the handling and playability of the skis.

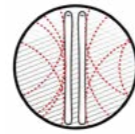

MULTI-RADIUS SHAPE

Drawing method that allows to vary the radius in several independent areas all along the ski. For instance, it allows to have a very short radius under the feet but greatly enlarged at the ends to improve tolerance in difficult snow.



TORSION

To get an ideal ratio adhesion/comfort, ZAG skis have a resistance to torsion value that evolves according to the widths and programs of the skis.



FLEX

ZAG skis are developed with the most progressive flex curves, always providing soften tip and rebound tail.



RESIN

The resin used in all ZAG models has been rigorously selected for its excellent bonding and mechanical strength properties. As far as possible, ZAG strives to use bio-sourced resins with minimum carbon impact.



FIBERS

In cooperation with its suppliers, ZAG has developed quality weaves adapted to the different constructions in its different ranges. This tailor-made weaving of glass, carbon and or Kevlar fibers, make possible the optimization of weight, strenght and ability of skis.



73.74

COLLECTION

AND BEET

78 85



ADRET 78

TOURING

An excellent compromise between being light and its skiability! The torsional stiffness of this ski increases its grip and creates a sense of security on hard pack on the downs just like on the ups. This is a ski dedicated to the ones who are looking for the ski for steep skiing, for mountaineering or even for high traverses. The ADRET 78 could also be for those who want a performance oriented ski for training purposes, its weight to skiability ratio is unbeatable.



LENGTH (cm)	DIMENSIONS (mm)	RADIUS (m)	WEIGHT (kg)
165	110 / 78 / 93	20	0.960
170	111 / 78 / 94	21	1.020
176	112 / 78 / 95	22	1.080

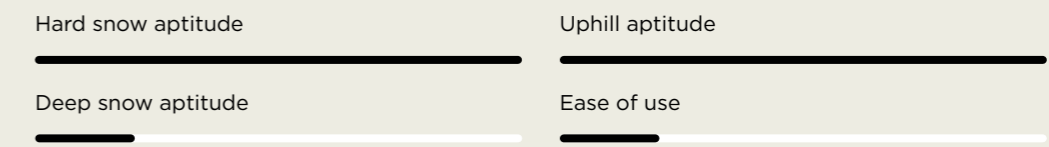

CONSTRUCTION & SHAPE



EXTRA LIGHT CONSTRUCTION

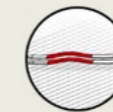

STRONG CAMBER



PROGRESSIVE TIP



STRONG FLEX



LONG CURVE RADIUS

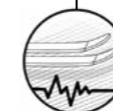

ADAPTIVE ABSORBER

Snow touch adapted & impressive adaptive dampening



100% WOOD CORE

Paulownia Durability & lightness



PHENOL PLATE

Reinforced binding



SAFETY GRIP

Shapes parameters optimized to get a really good grip



MULTIAXIAL GLASS & CARBON FIBER

Lightness & resistance



ADRET 85

TOURING

A light ski developed for skiers that want to feel secure on hard pack with a great skiability. The ADRET 85 Lady was imagined for tourers that are looking for a mountaineering ski with no compromises.



LENGTH (cm)	DIMENSIONS (mm)	RADIUS (m)	WEIGHT (kg)
155	114 / 85 / 99	18	0.960
160	115 / 85 / 100	19	1.000
166	115.5 / 85 / 101	20	1.030

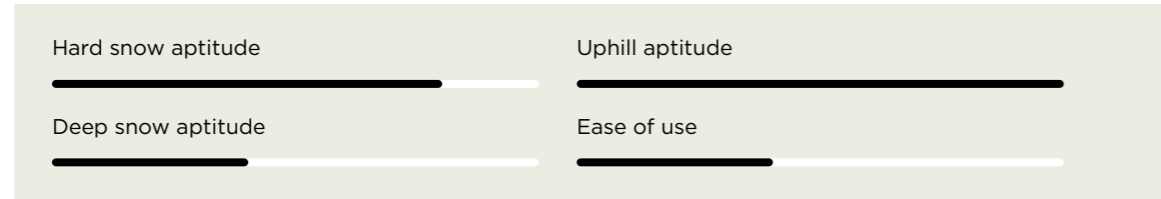

ADRET 85

TOURING

A ski more versatile than its bigger brother, the ADRET 78. This versatility is achieved by its larger waist and torsional stiffness, making it great in all types of snow with great grip on hard pack. The ADRET 85 is the perfect combination of light, durable and skiability.



LENGTH (cm)	DIMENSIONS (mm)	RADIUS (m)	WEIGHT (kg)
166	115.5 / 85 / 101	20	1.030
172	116 / 85 / 102	21	1.100
178	117 / 85 / 103	22	1.200

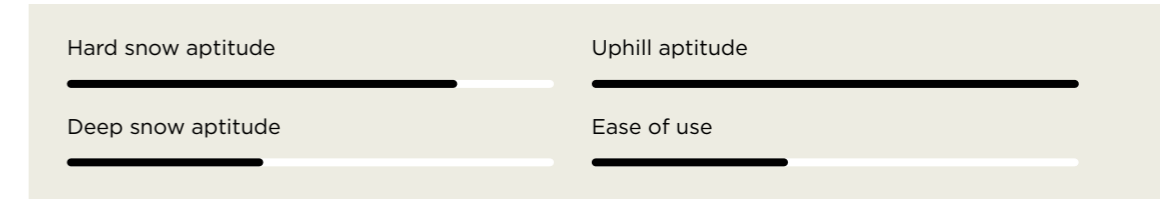

CONSTRUCTION & SHAPE



EXTRA LIGHT CONSTRUCTION

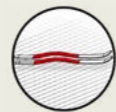

STRONG CAMBER



PROGRESSIVE TIP



MODERATE FLEX



LONG CURVE RADIUS

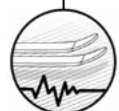

ADAPTIVE ABSORBER

Snow touch adapted & impressive adaptive dampening



100% WOOD CORE

Paulownia Durability & lightness



PHENOL PLATE

Reinforced binding



SAFETY GRIP

Shapes parameters optimized to get a really good grip



MULTIAXIAL GLASS & CARBON FIBER

Lightness & resistance

CONSTRUCTION & SHAPE



EXTRA LIGHT CONSTRUCTION

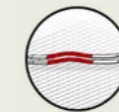

STRONG CAMBER



PROGRESSIVE TIP



MODERATE FLEX



LONG CURVE RADIUS

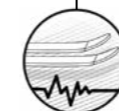

ADAPTIVE ABSORBER

Snow touch adapted & impressive adaptive dampening

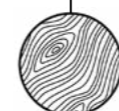

100% WOOD CORE

Paulownia Durability & lightness



PHENOL PLATE

Reinforced binding



SAFETY GRIP

Shapes parameters optimized to get a really good grip



MULTIAXIAL GLASS & CARBON FIBER

Lightness & resistance

73.74

COLLECTION

UBAUG

89 95 102 112



UBAC 89 LADY

TOURING

The minimalist weight allows lighter riders a technical tool for long missions with great skiability especially in the hard snow a in the high mountains.

LENGTH (cm)	DIMENSIONS (mm)	RADIUS (m)	WEIGHT (kg)
156	120 / 89 / 106	16	1.150
164	121 / 89 / 107	17	1.210
171	122 / 89 / 107.5	19	1.280

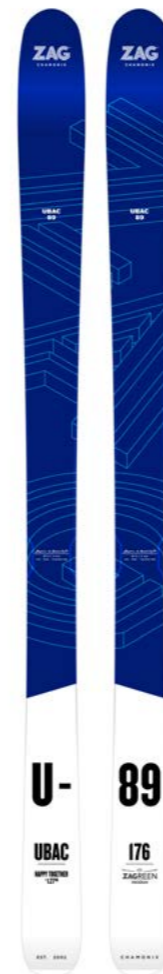
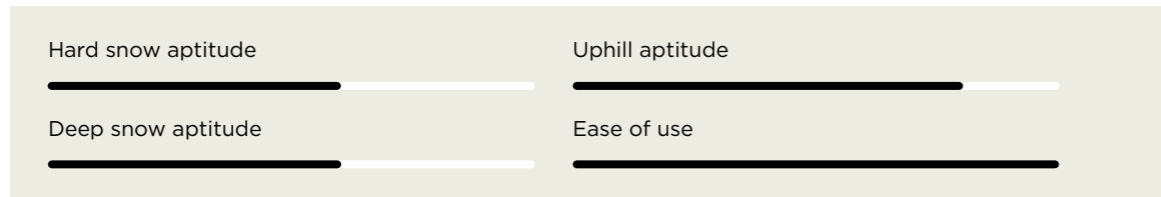

UBAC 89

TOURING

Its minimalist weight allows long trips without any effort. Besides, its excellent adhesion in downhill gives a feeling of safety in all types of snow and excels on hard snow.

LENGTH (cm)	DIMENSIONS (mm)	RADIUS (m)	WEIGHT (kg)
171	122 / 89 / 107.5	19	1.280
176	123 / 89 / 108	20	1.350
183	124 / 89 / 109	21	1.420

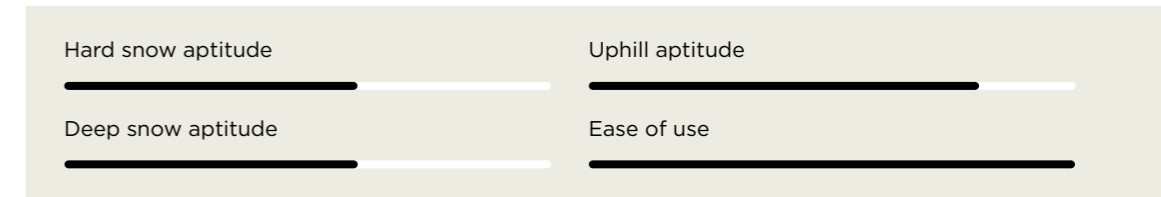

CONSTRUCTION & SHAPE



LIGHT CONSTRUCTION

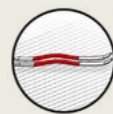

STRONG CAMBER



DOUBLE ROCKER



STRONG FLEX



MEDIUM CURVE RADIUS

CONSTRUCTION & SHAPE



LIGHT CONSTRUCTION

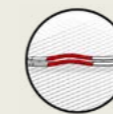

STRONG CAMBER

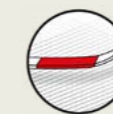

DOUBLE ROCKER



STRONG FLEX



MEDIUM CURVE RADIUS

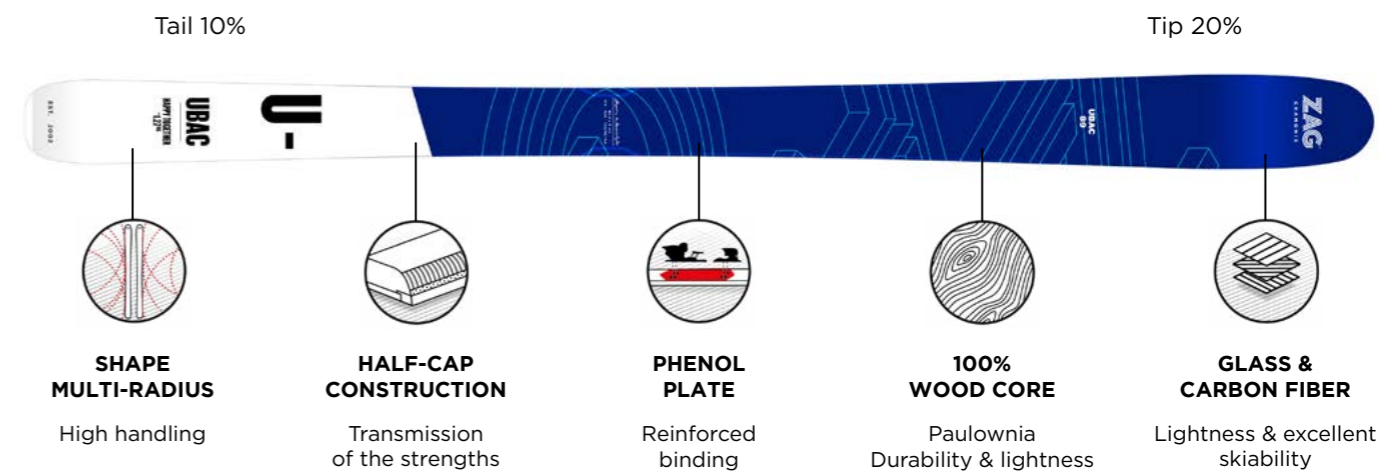
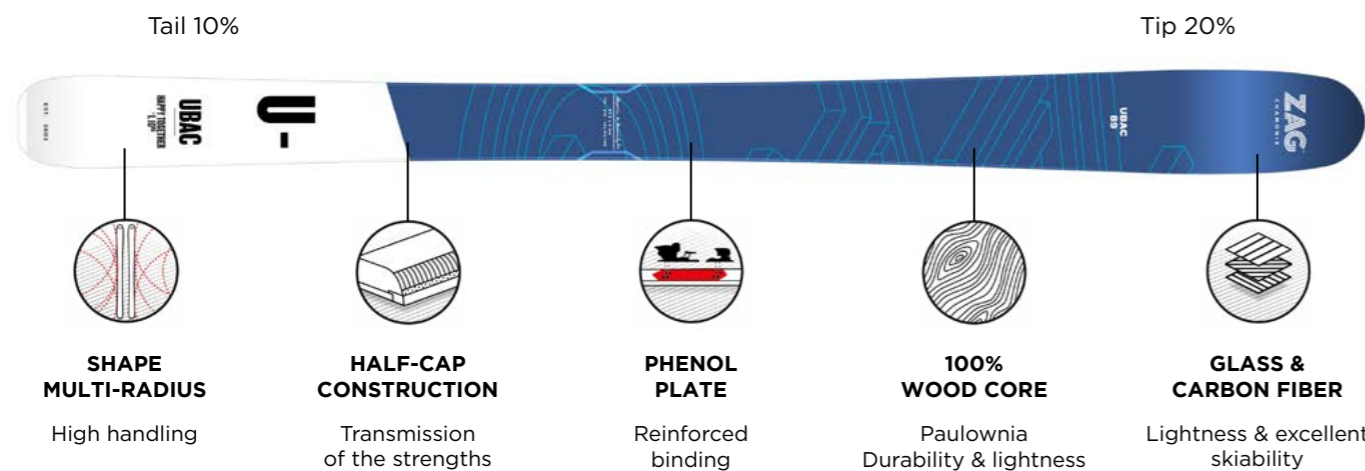



UBAC 95 LADY

TOURING

The perfect ski for ski-touring-ladies looking for a light ski without losing comfort and pleasure in the descent. The best weight/performance ratio on the market.

LENGTH (cm)	DIMENSIONS (mm)	RADIUS (m)	WEIGHT (kg)
158	126 / 94 / 112.5	15	1.190
164	127 / 94 / 114	16	1.260
170	128.5 / 95 / 115	16.8	1.300

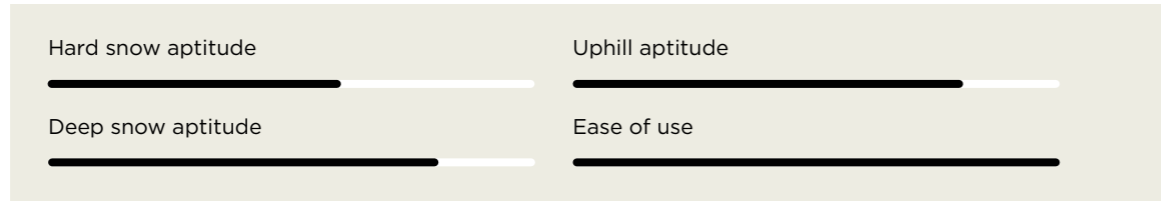

UBAC 95

TOURING

Developed by and for the guides of Chamonix. Re-invented in our ZAGLab. It is more stable and playful in all types of snow. The best weight/performance ratio on the market.

LENGTH (cm)	DIMENSIONS (mm)	RADIUS (m)	WEIGHT (kg)
170	128.5 / 95 / 115	16.8	1.300
174	129 / 95 / 116	17.8	1.350
178	129.5 / 95.5 / 116	18.5	1.420
184	130.5 / 96 / 117	19.5	1.480

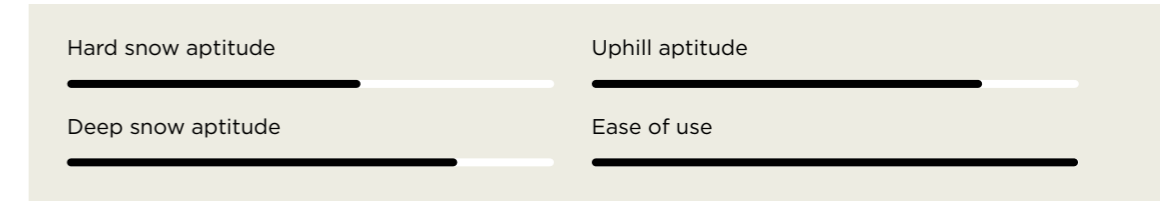

CONSTRUCTION & SHAPE



LIGHT CONSTRUCTION

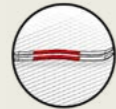

MEDIUM CAMBER



DOUBLE ROCKER



MEDIUM FLEX



SHORT CURVE RADIUS

CONSTRUCTION & SHAPE



LIGHT CONSTRUCTION

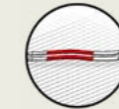

MEDIUM CAMBER



DOUBLE ROCKER



STRONG FLEX



SHORT CURVE RADIUS

Tail 20%

Tip 30%

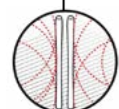
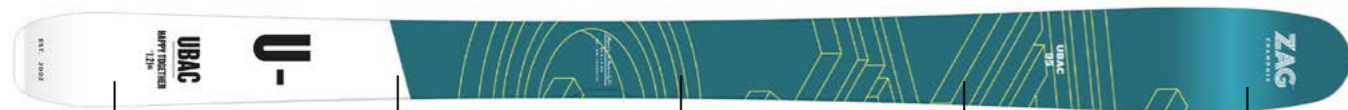

MULTI-RADIUS SHAPE

High handling



HALF-CAP CONSTRUCTION

Transmission of the strengths



PHENOL PLATE

Reinforced mounting plate
Durability



100% WOOD CORE

Paulownia
Durability & lightness



GLASS & CARBON FIBER

Lightness & excellent
skiability

Tail 20%

Tip 30%

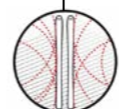
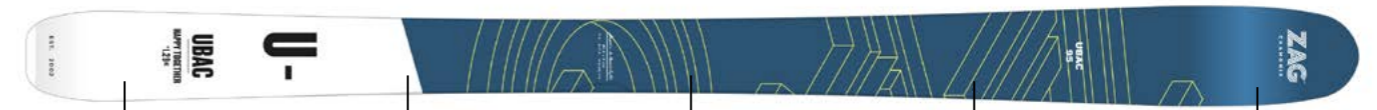

SHAPE MULTI-RADIUS

High handling

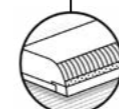

HALF-CAP CONSTRUCTION

Transmission of the strengths



PHENOL PLATE

Reinforced mounting plate
Durability



100% WOOD CORE

Paulownia
Durability & lightness



GLASS & CARBON FIBER

Lightness & excellent
skiability



UBAC 102

TOURING

Big brother of the UBAC 95, these skis will push you to your limits. A weapon in powder snow and at high speed.

LENGTH (cm)	DIMENSIONS (mm)	RADIUS (m)	WEIGHT (kg)
164	133 / 102 / 118	17	1.290
170	134.5 / 102 / 118.5	18	1.350
176	135.5 / 102 / 119	20.5	1.450
184	136.5 / 102 / 119.5	21.5	1.590
188	133.5 / 96 / 118	22	1.690

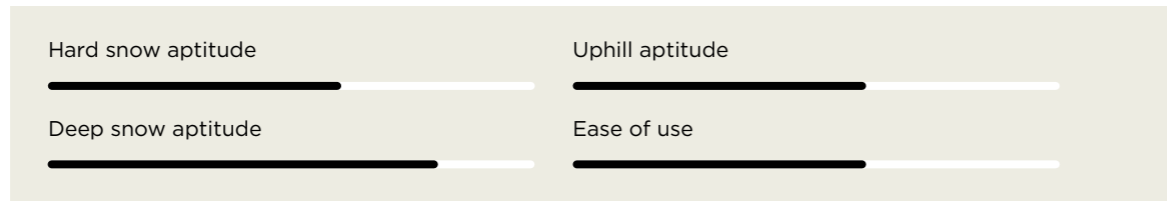

UBAC 112

TOURING

Big mountain skis with relevant touring weights. The generous widths provide large floatation for deep snow and stability at speed. It is made for hikers looking for unexplored spaces even in the most remote corners.

LENGTH (cm)	DIMENSIONS (mm)	RADIUS (m)	WEIGHT (kg)
176	141 / 112 / 118.5	19.5	1.490
184	144 / 114 / 132	21	1.640

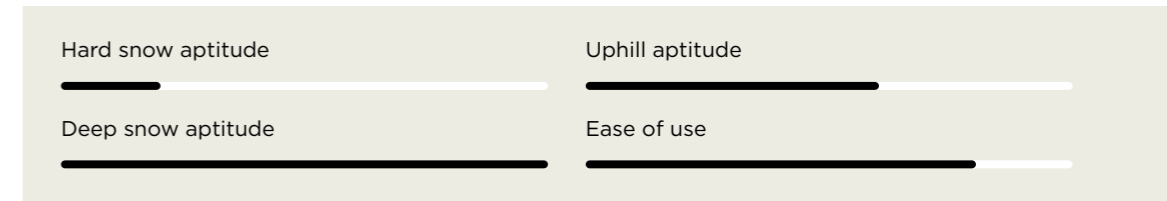

CONSTRUCTION & SHAPE



LIGHT CONSTRUCTION

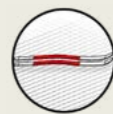

MEDIUM CAMBER



DOUBLE ROCKER



MEDIUM FLEX



SHORT CURVE RADIUS

CONSTRUCTION & SHAPE



LIGHT CONSTRUCTION

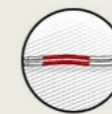

MEDIUM CAMBER

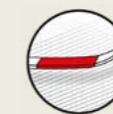

DOUBLE ROCKER



STRONG FLEX



SHORT CURVE RADIUS

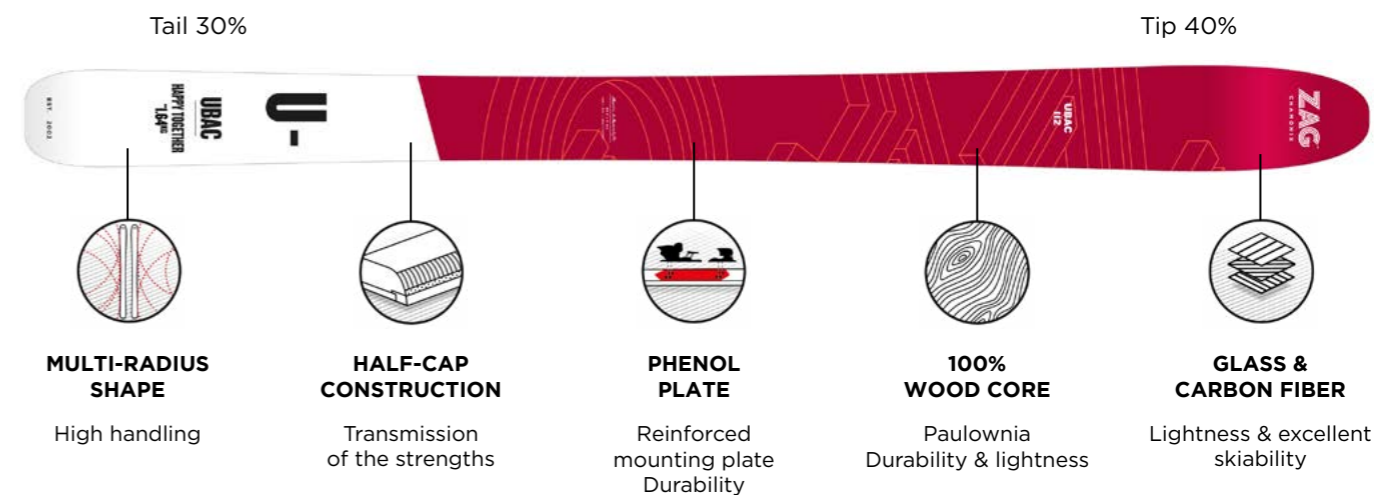
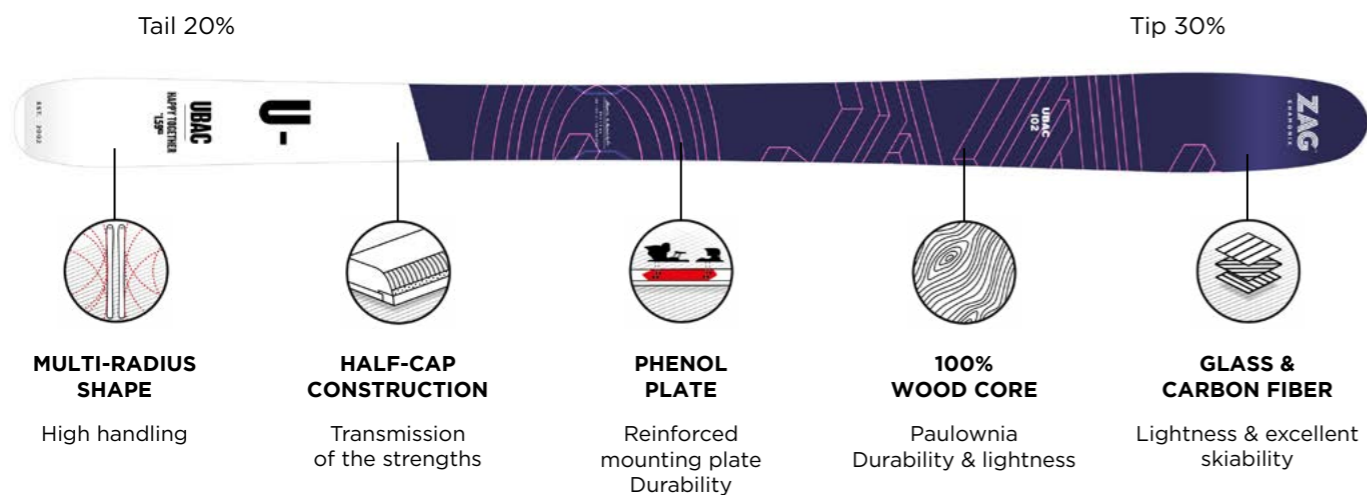

73.74

COLLECTION

HARBREAFANO

86 96 106

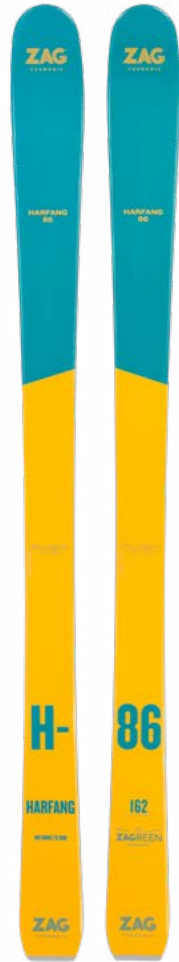

HARFANG 86 LADY

ALL-MOUNTAIN / PISTE

Handling ability and comfortable in all conditions, this ski is ideal for all surfaces female or lighter framed skier looking for a versatile front country ski.

LENGTH (cm)	DIMENSIONS (mm)	RADIUS (m)	WEIGHT (kg)
155	125 / 85 / 108	14	1.46
162	126 / 85 / 109	15	1.56
170	126 / 85 / 111	16	1.64



HARFANG 86

ALL-MOUNTAIN / PISTE

The ideal all mountain ski to charge on resort. The progressive sidecut will ensure easy turning and edge to edge power transfer.

LENGTH (cm)	DIMENSIONS (mm)	RADIUS (m)	WEIGHT (kg)
170	126 / 86 / 111	16	1.64
177	126 / 86 / 112	17	1.8
184	129 / 86 / 113.4	18	1.9

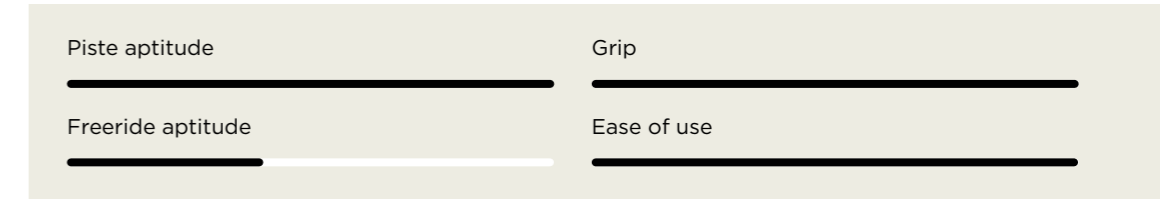

CONSTRUCTION & SHAPE



HEAVY DUTY CONSTRUCTION

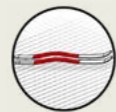

STRONG CAMBER



TIP ROCKER



STRONG FLEX



STRONG TORSION

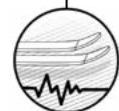

ADAPTIVE ABSORBER

Snow-touch adapted + impressive adaptive dampening



HALF-CAP CONSTRUCTION

Transmission of the strengths



100% WOOD CORE

Paulownia wood Durability



SHORT CURVE RADIUS

Reinforced binding



MULTI-AXIAL FIBER

Reinforced strength

CONSTRUCTION & SHAPE



HEAVY DUTY CONSTRUCTION

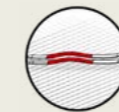

STRONG CAMBER



TIP ROCKER



STRONG FLEX



STRONG TORSION

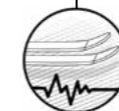
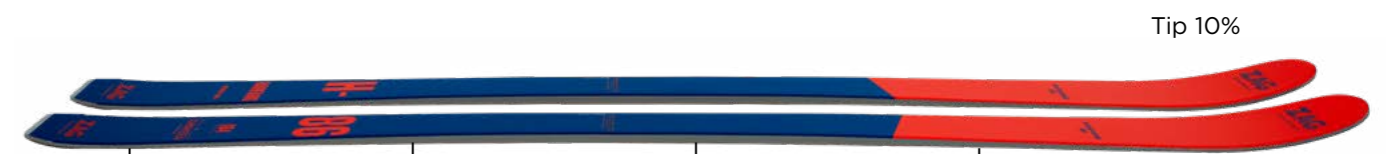

ADAPTIVE ABSORBER

Snow-touch adapted + impressive adaptive dampening

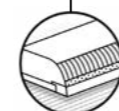

HALF-CAP CONSTRUCTION

Transmission of the strengths



100% WOOD CORE

Paulownia wood Durability



SHORT CURVE RADIUS

Reinforced binding



MULTI-AXIAL FIBER

Reinforced strength



HARFANG 96 LADY

ALL-MOUNTAIN / PISTE

An excellent 4x4 machine on and off-piste. With great adhesion on hard snow and impressive floatation in powder snow. The most versatile woman's ski in the line !

LENGTH (cm)	DIMENSIONS (mm)	RADIUS (m)	WEIGHT (kg)
156	127 / 94 / 111.5	15.5	1.59
164	131 / 96 / 115.5	17	1.62
170	131 / 96 / 115.5	17.5	1.64

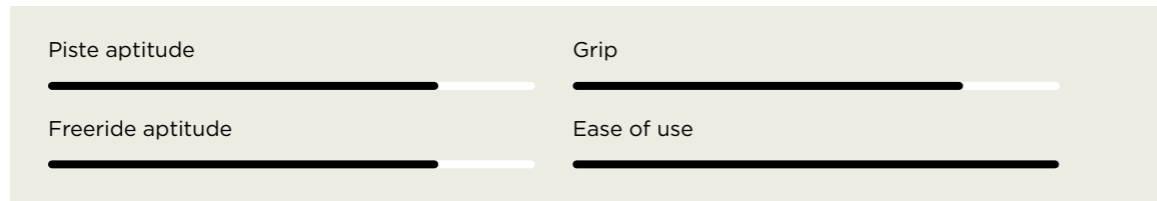

HARFANG 96

ALL-MOUNTAIN / PISTE

The most versatile ski of the line. It adapts to all snow conditions, all speeds and all snow types.

LENGTH (cm)	DIMENSIONS (mm)	RADIUS (m)	WEIGHT (kg)
170	131 / 96 / 115.5	17.5	1.76
176	131.5 / 96 / 116	18.5	1.9
182	132.5 / 96 / 117	20	1.99
188	133.5 / 96 / 118	21	2.05

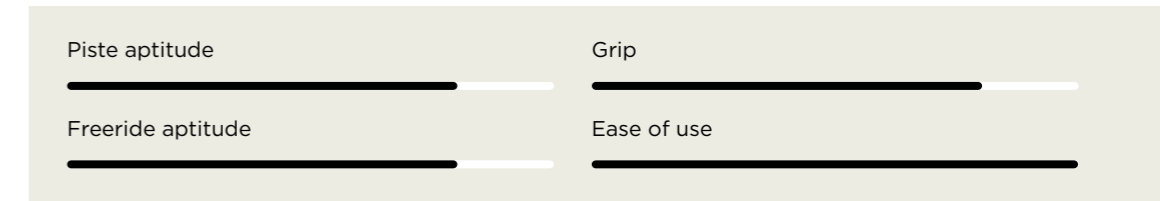

CONSTRUCTION & SHAPE



HEAVY DUTY CONSTRUCTION

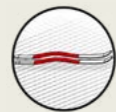

STRONG CAMBER



DOUBLE ROCKER



MEDIUM FLEX



MEDIUM TORSION

CONSTRUCTION & SHAPE



HEAVY DUTY CONSTRUCTION

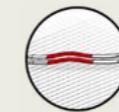

STRONG CAMBER



TIP ROCKER



MEDIUM FLEX



MEDIUM TORSION

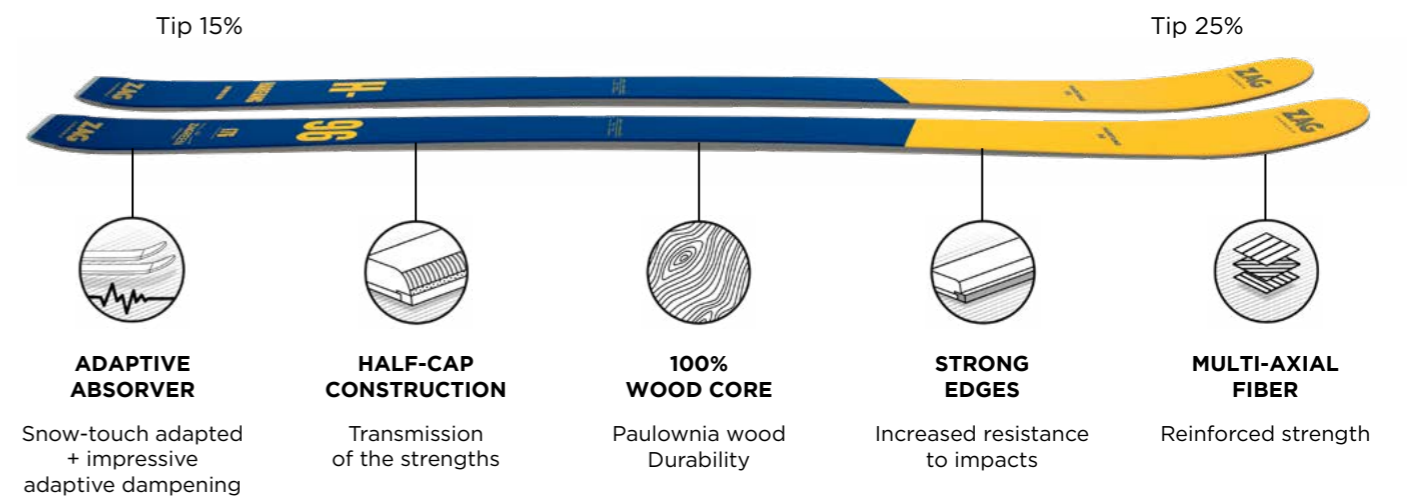
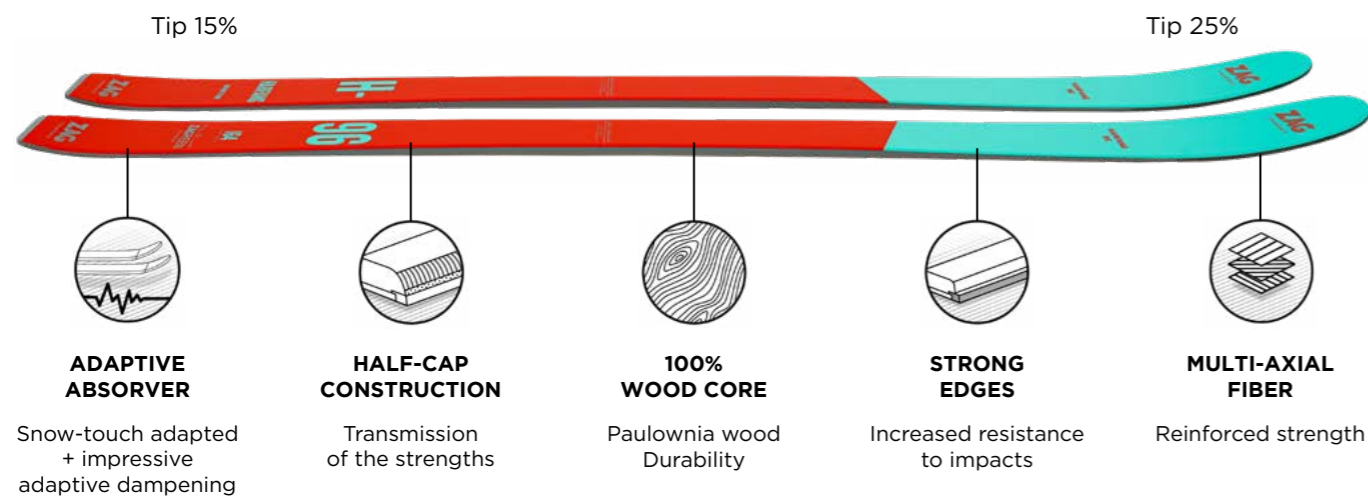



HARFANG 106

ALL-MOUNTAIN / FREERIDE

The ultimate freerider's weapon !
Performance in all conditions.

LENGTH (cm)	DIMENSIONS (mm)	RADIUS (m)	WEIGHT (kg)
178	137 / 106 / 122	20	2.00
186	139.5 / 106 / 124.5	21.5	2.10
192	140.5 / 106 / 125.5	22.5	2.20

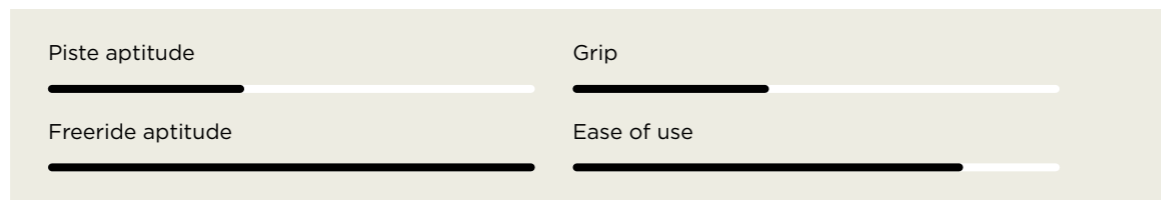

CONSTRUCTION & SHAPE



HEAVY DUTY CONSTRUCTION

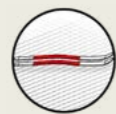

MODERATE CAMBER



DOUBLE ROCKER



STRONG FLEX



MEDIUM TORSION

Tip 25%

Tip 35%

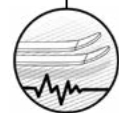

ADAPTIVE ABSORBER

Snow-touch adapted + impressive adaptive dampening

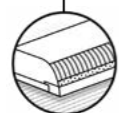

HALF-CAP CONSTRUCTION

Transmission of the strengths

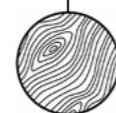

100% WOOD CORE

Paulownia wood Durability

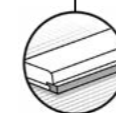

STRONG EDGES

Increased resistance to impacts



MULTI-AXIAL FIBER

Reinforced strength





SLAP 92 LADY

ALL-MOUNTAIN / FREETOURING

A SLAP particularly effecient in all conditions. In addition to its ease in carving, the ski pivots very easily. A first from ZAG! The transition between turns is even more intuitive than the rest of the lineup. The SLAP 92 Lady feels perfect under the feet giving the skier a sense of power and control. A great compromise between good grip on hard pack and good float in powder. This ski was imagined and devolpeded for the skiers that want one ski to do it all. The embodiment of versatility.

LENGTH (cm)	DIMENSIONS (mm)	RADIUS (m)	WEIGHT (kg)
160	123 / 91 / 109	16.8	1.620
166	124 / 92 / 110	17.5	1.740

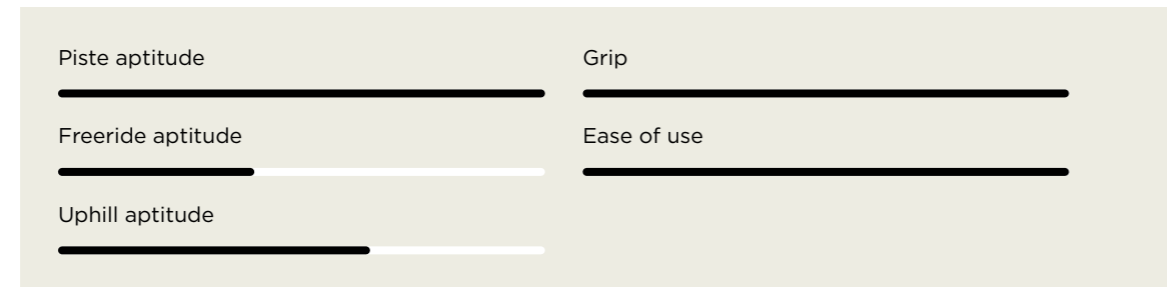

SLAP 92

ALL-MOUNTAIN / FREETOURING

A SLAP particularly effecient in all conditions. In addition to its ease in carving, the ski pivots very easily. A first from ZAG! The transition between turns is even more intuitive than the rest of the lineup. The SLAP 92 feels perfect under the feet giving the skier a sense of power and control. A great compromise between good grip on hard pack and good float in powder. This ski was imagined and devolpeded for the skiers that want one ski to do it all. The embodiment of versatility.

LENGTH (cm)	DIMENSIONS (mm)	RADIUS (m)	WEIGHT (kg)
173	126 / 92 / 112.2	18.3	1.620
178	127 / 92 / 113.2	19	1.740
185	128 / 92 / 114	20	1.840

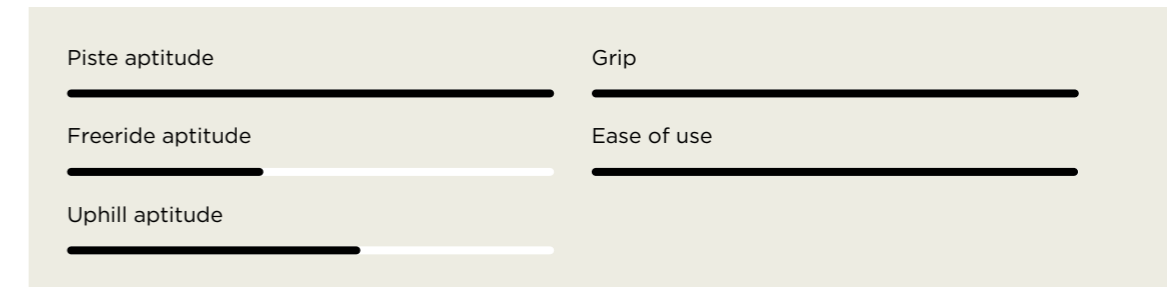

CONSTRUCTION & SHAPE



HEAVY DUTY LIGHT CONSTRUCTION

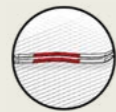

MODERATE CAMBER



DOUBLE ROCKER



MODERATE FLEX



ADAPTIVE PIVOT CONTROL

CONSTRUCTION & SHAPE



HEAVY DUTY LIGHT CONSTRUCTION

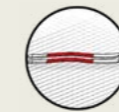

MODERATE CAMBER



DOUBLE ROCKER



MODERATE FLEX



ADAPTIVE PIVOT CONTROL

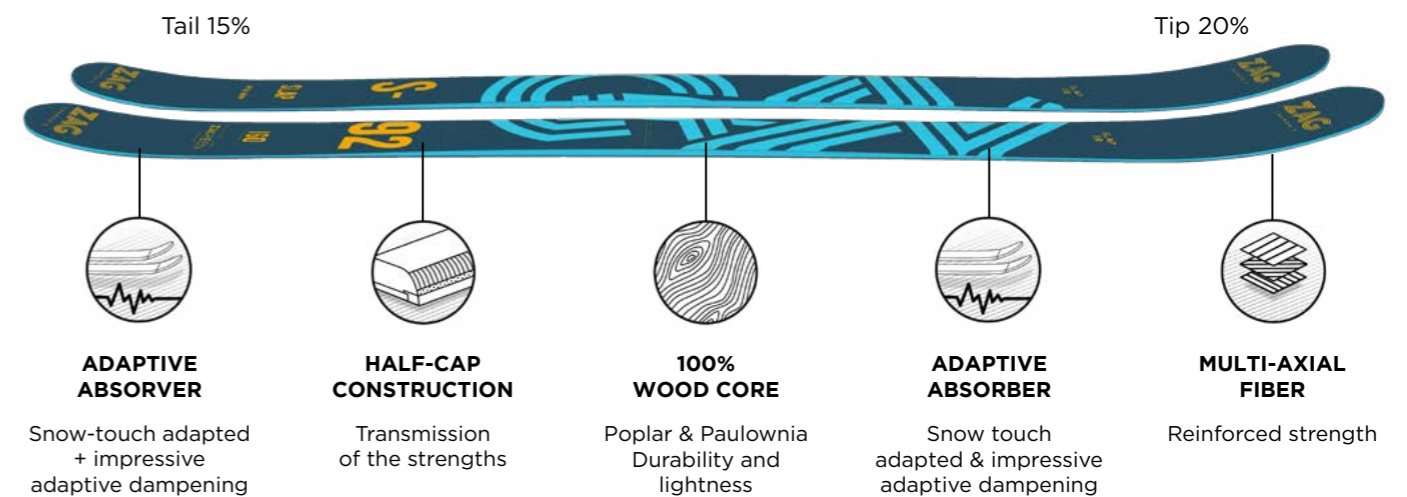
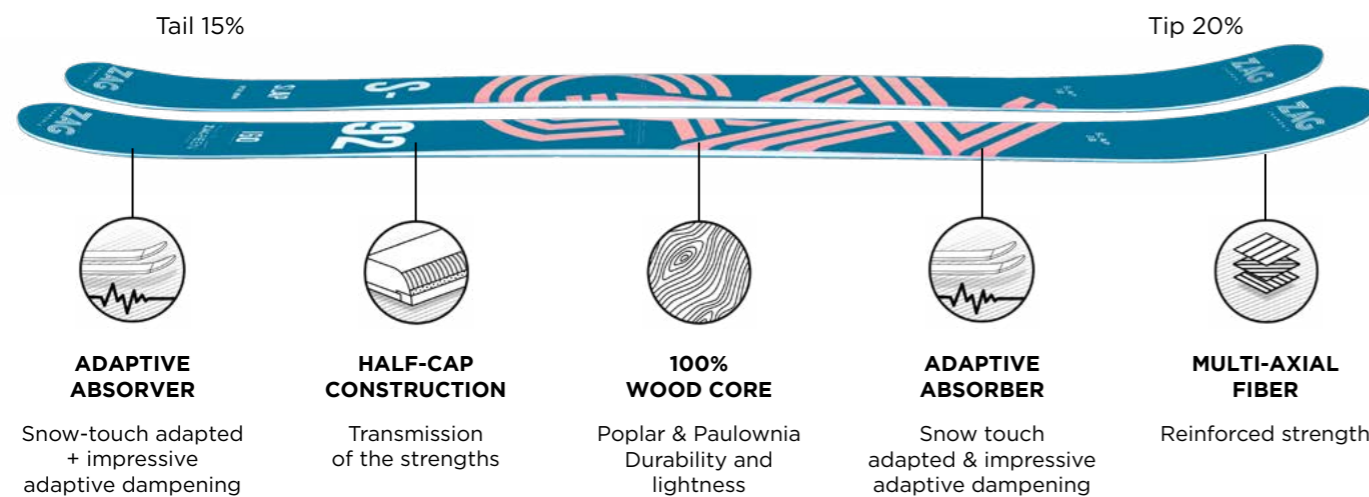



SLAP 98 LADY

ALL-MOUNTAIN / FREETOURING

A SLAP particularly effecient in all conditions. In addition to its ease in carving, the ski pivots very easily. A first from ZAG! The transition between turns is even more intuitive than the rest of the lineup. The SLAP 98 Lady feels perfect under the feet giving the skier a sense of power and control. A great compromise between good grip on hard pack and good float in powder. This ski was imagined and devolpeded for the skiers that want one ski to do it all. The embodiment of versatility.

LENGTH (cm)	DIMENSIONS (mm)	RADIUS (m)	WEIGHT (kg)
160	127 / 98 / 113	16	1.580
166	128 / 98 / 114	17	1.700
173	129 / 98 / 115	18.5	1.800

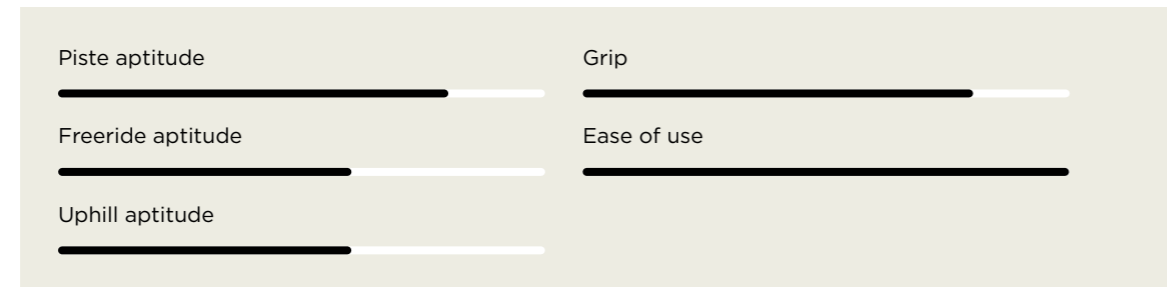

SLAP 98

ALL-MOUNTAIN / FREETOURING

A SLAP particularly effecient in all conditions. In addition to its ease in carving, the ski pivots very easily. A first from ZAG! The transition between turns is even more intuitive than the rest of the lineup. The SLAP 98 Lady feels perfect under the feet giving the skier a sense of power and control. A great compromise between good grip on hard pack and good float in powder. This ski was imagined and devolpeded for the skiers that want one ski to do it all. The embodiment of versatility.

LENGTH (cm)	DIMENSIONS (mm)	RADIUS (m)	WEIGHT (kg)
173	129 / 98 / 115	18,5	1.800
180	130 / 98 / 116.5	20	1.900
187	131 / 98 / 117	21	2.000

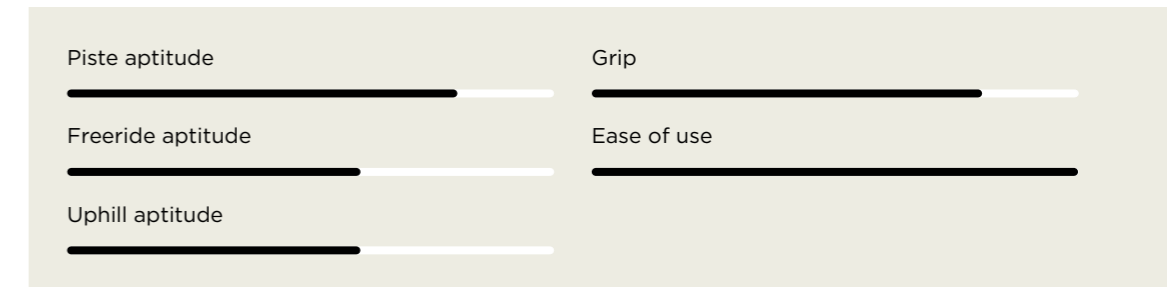

CONSTRUCTION & SHAPE



HEAVY DUTY LIGHT CONSTRUCTION

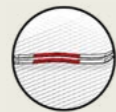

MODERATE CAMBER



DOUBLE ROCKER



MODERATE FLEX



ADAPTIVE PIVOT CONTROL

CONSTRUCTION & SHAPE



HEAVY DUTY LIGHT CONSTRUCTION

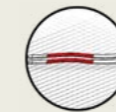

MODERATE CAMBER



DOUBLE ROCKER



MODERATE FLEX

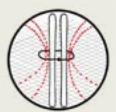

ADAPTIVE PIVOT CONTROL

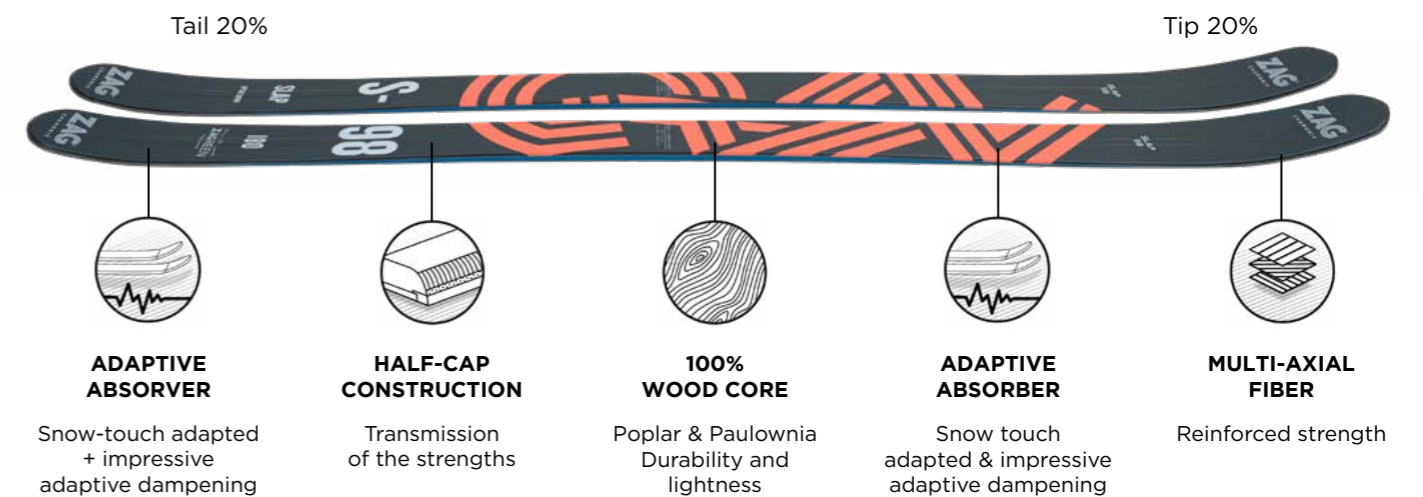
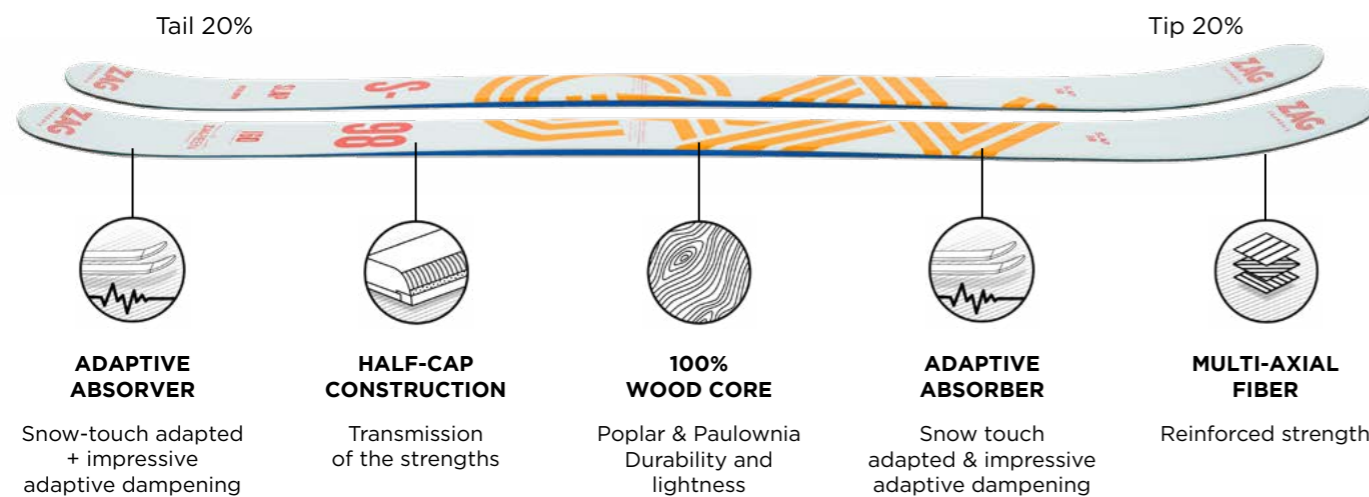



SLAP 104 LADY

FREETOURING / FREERIDE

Intrigued by freeride but unready to leave the groomers forever? Light and playful on all terrain! The legendary versatility of SLAP-104 is made... Easy in difficult snow, the SLAP-104 permits skiers to play with off-piste terrain but also carve long turns thanks to its excellent traction on hard and groomed snow.

LENGTH (cm)	DIMENSIONS (mm)	RADIUS (m)	WEIGHT (kg)
164	132.5 / 102 / 121	16	1.620
170	133.5 / 103 / 122	17	1.780

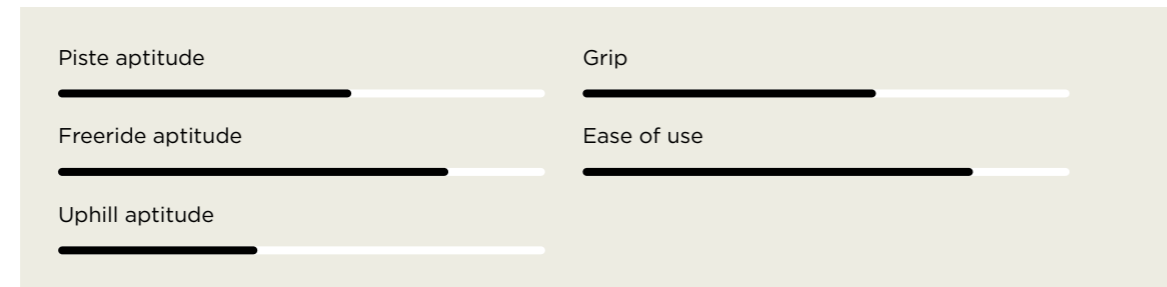

SLAP 104

FREETOURING / FREERIDE

Intrigued by freeride but unready to leave the groomers forever? Light and playful on all terrain! The legendary versatility of SLAP-104 is made... Easy in difficult snow, the SLAP-104 permits skiers to play with off-piste terrain but also carve long turns thanks to its excellent traction on hard and groomed snow.

LENGTH (cm)	DIMENSIONS (mm)	RADIUS (m)	WEIGHT (kg)
176	134 / 103 / 123	18.5	1.820
182	136 / 104 / 125.2	19	1.940
188	137 / 104 / 126	20	1.990

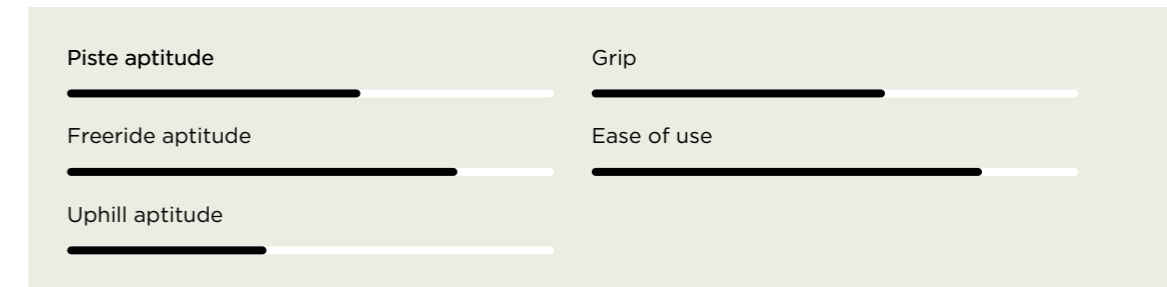

CONSTRUCTION & SHAPE



HEAVY DUTY LIGHT CONSTRUCTION

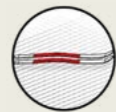

MODERATE CAMBER



DOUBLE ROCKER



MODERATE FLEX



SHORT CURVE RADIUS

CONSTRUCTION & SHAPE



HEAVY DUTY LIGHT CONSTRUCTION

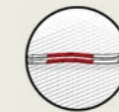

MODERATE CAMBER



DOUBLE ROCKER



MODERATE FLEX



SHORT CURVE RADIUS

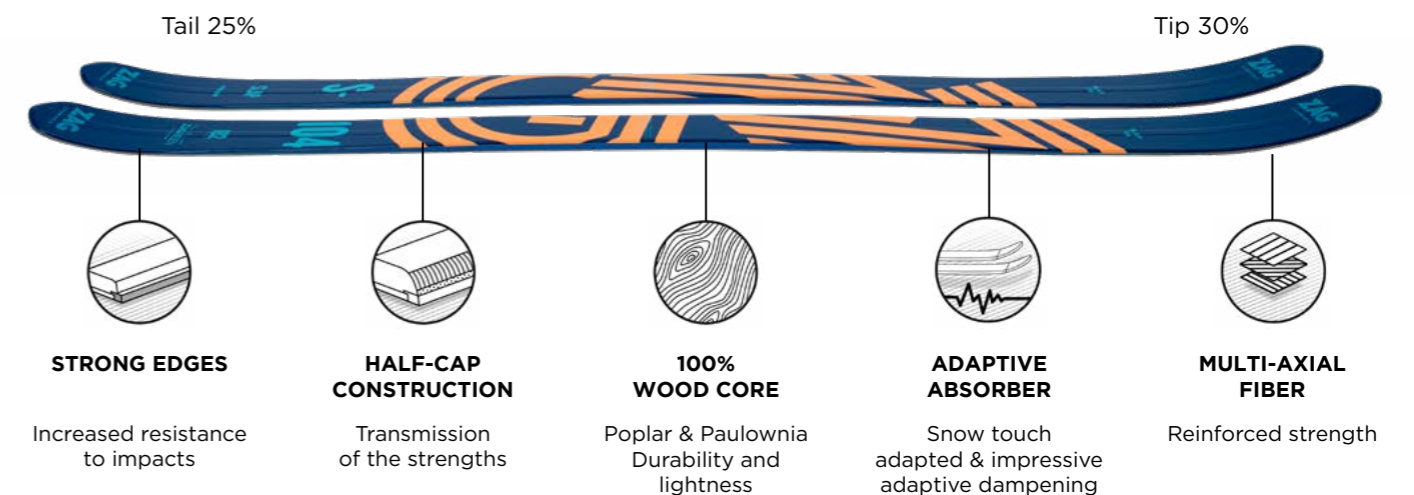
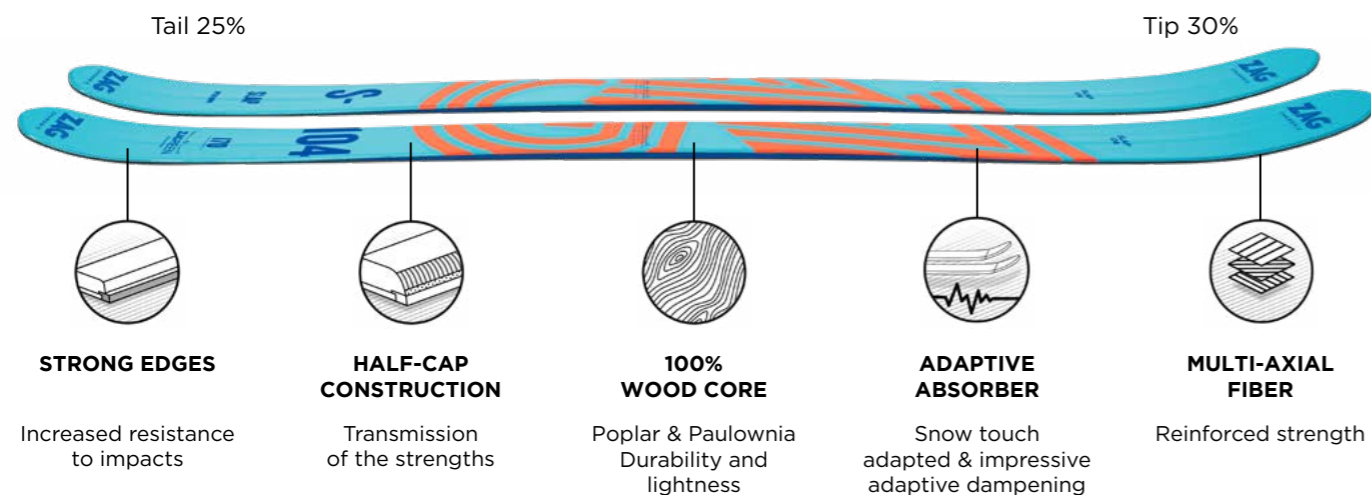



SLAP 112 LADY

FREETOURING / FREERIDE

Skiing by Wadek Gorak, winner of the legendary «Verbier Xtreme» stage on the Freeride World Tour. These skis allow you to reach exceptional speeds and cruising in absolute comfort. Lightweight and easy to put on the bag for freerando practice.

LENGTH (cm)	DIMENSIONS (mm)	RADIUS (m)	WEIGHT (kg)
164	137 / 109 / 126	17	1.740
170	137 / 110 / 127	18.5	1.800

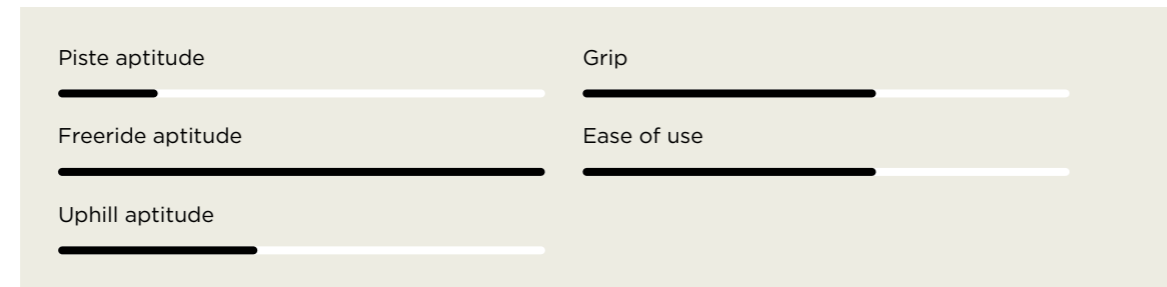

SLAP 112

FREETOURING / FREERIDE

Intrigued by freeride but unready to leave the groomers forever? Light and playful on all terrain! The legendary versatility of SLAP-104 is made... Easy in difficult snow, the SLAP-104 permits skiers to play with off-piste terrain but also carve long turns thanks to its excellent traction on hard and groomed snow.

LENGTH (cm)	DIMENSIONS (mm)	RADIUS (m)	WEIGHT (kg)
176	138.5 / 111 / 127	19.5	1.840
182	139.5 / 111 / 128.5	20.5	1.970
188	141 / 112 / 130	22	2.010

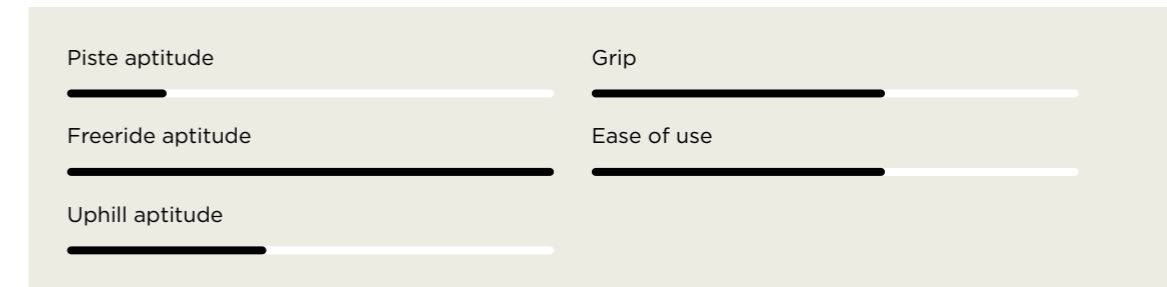

CONSTRUCTION & SHAPE



HEAVY DUTY LIGHT CONSTRUCTION

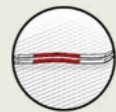

LOW CAMBER



DOUBLE ROCKER



STRONG FLEX



MEDIUM CURVE RADIUS

CONSTRUCTION & SHAPE



HEAVY DUTY LIGHT CONSTRUCTION

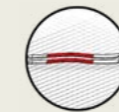

MODERATE CAMBER



DOUBLE ROCKER



MODERATE FLEX



MEDIUM CURVE RADIUS

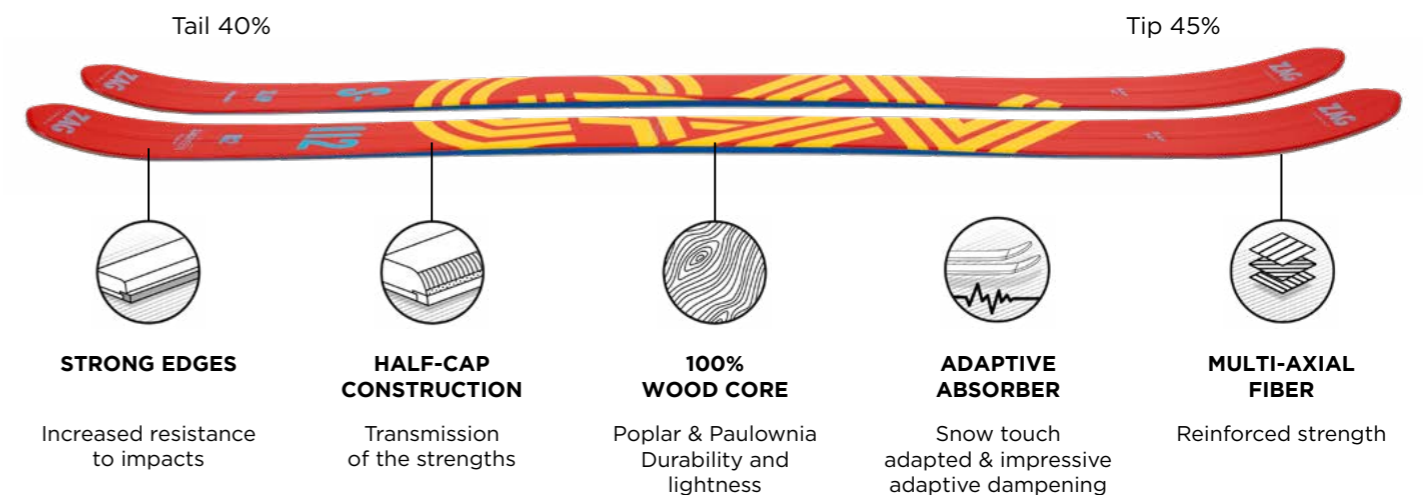
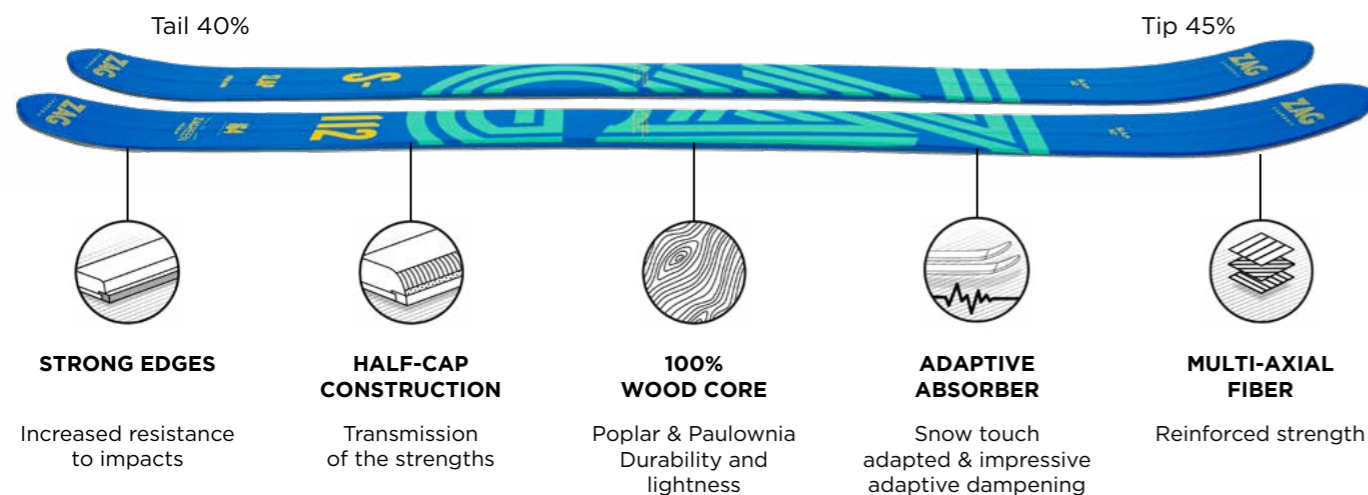



SLAP 122

FREERIDE

An exceptional lift in the deep snows that make it the ultimate weapon in the forest and in the big fields of powder.

LENGTH (cm)	DIMENSIONS (mm)	RADIUS (m)	WEIGHT (kg)
180	144 / 120 / 134	16	2.010
186	146 / 122 / 136	18	2.050
193	148 / 124 / 138	20	2.080

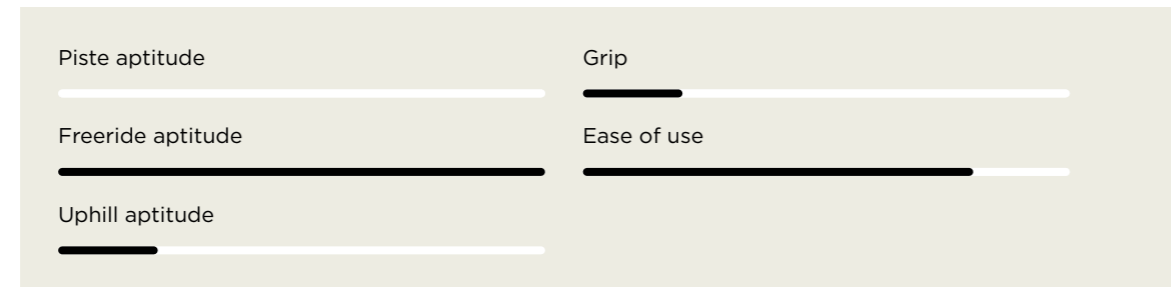

SLAP JUNIOR

FREERIDE / FREETOURING

WARNING: May produce future freeride ski champions! These skis will allow young riders to experience the benefits of a performance ski and challenge their elders in all types of snow: from the track to the freeride via touring.

LENGTH (cm)	DIMENSIONS (mm)	RADIUS (m)	WEIGHT (kg)
137	116 / 81 / 101	12	1.05
147	119 / 86 / 104	14	1.2
157	120 / 87 / 105	15	1.35
165	122 / 89 / 107	16	1.45

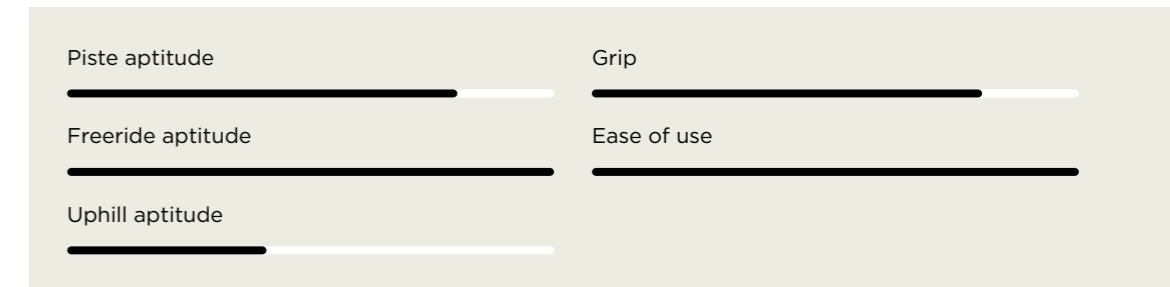

CONSTRUCTION & SHAPE



HEAVY DUTY LIGHT CONSTRUCTION

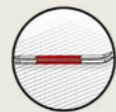

LOW CAMBER



DOUBLE ROCKER



STRONG FLEX



SHORT CURVE RADIUS

CONSTRUCTION & SHAPE



HEAVY DUTY LIGHT CONSTRUCTION

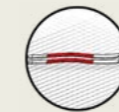

MODERATE CAMBER



DOUBLE ROCKER



MODERATE FLEX



SHORT CURVE RADIUS

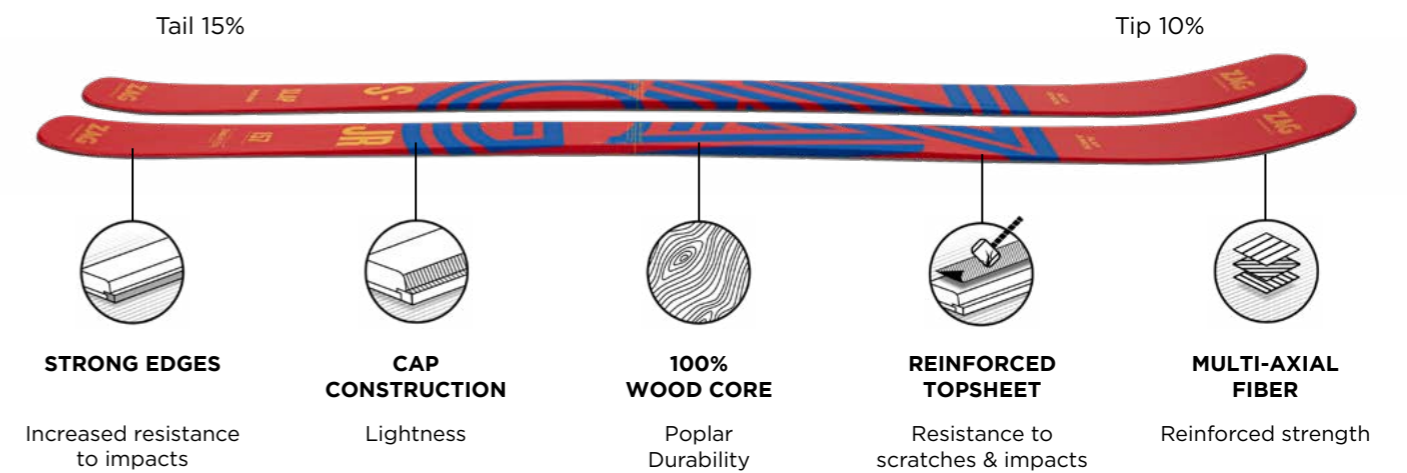
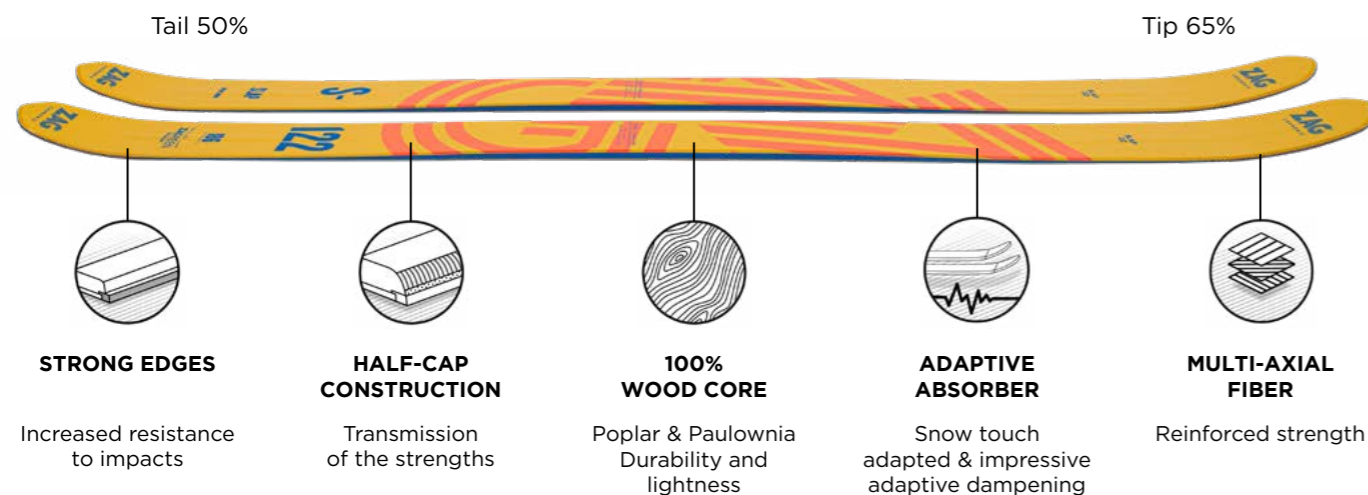

ACCESSORIES

POLES BINDINGS

SKINS APPAREL

POLES

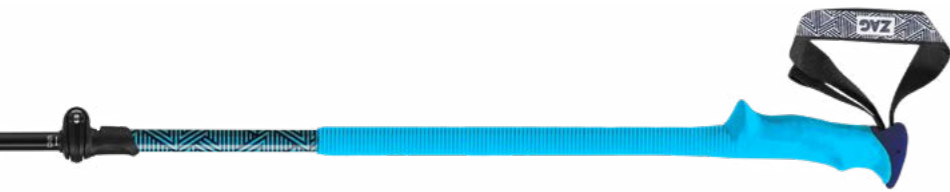

BLUE NORTH POLE

TOURING
245gr
vario : 105 to 140 cm
Available in two colors

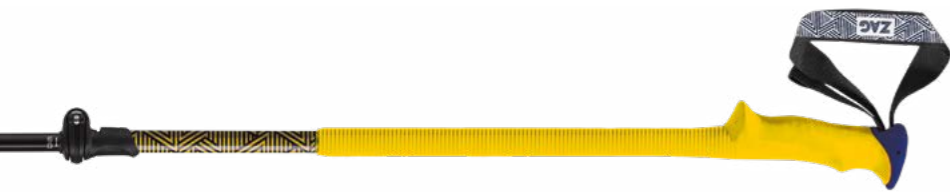

YELLOW NORTH POLE



SOUTH POLE

TOURING
245gr
sizes : 110, 115, 120, 125, 130 cm



Z SAFE SYSTEM

Grip and easily adjusting strap with safety release.



ERGO GRIP

Ergonomic handle material EVA anti slip and ultra-comfort.



LIGHTNESS & RESISTANCE

Aluminium Grad Aéro Spatial.

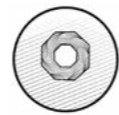

BASKET

Large & soft basket for hanging in the backs.



TUNGSTEN TIP

Long and durable tip.

SKI BINDINGS

TOURING



ATK HAUTE ROUTE 10

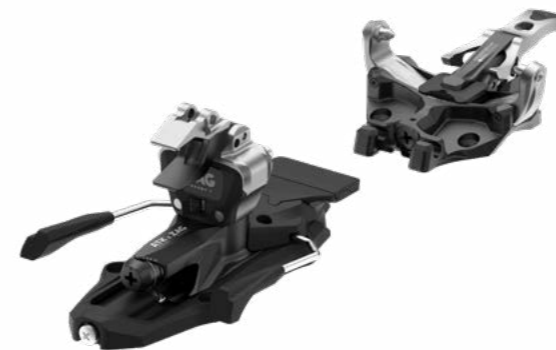

ATK RAIDER II EVO



ATK RAIDER II EVO

ALPIN



LOOK XPRESS 10



LOOK NX 12



LOOK NX 7



SKINS

POMOCA TOUR EXPLORER

Composition : 70% Mohair, 30% Nylon
 Designed for experienced ski tourers and amateur competitors, the Climb Pro Glide mixed structure skin is ideal for multi-day expeditions, offering extra performance and gliding qualities.

MODELS	SIZES (mm)
Adret 78	162 / 170 / 177
Adret 85L/85	156 / 163 / 169 / 174 / 182
Ubac 89L/89	156 / 164 / 171 / 176 / 183
Ubac 95L/95	158 / 164 / 170 / 174 / 178 / 184
Ubac 102	164 / 170 / 176 / 184 / 188
Ubac 112	176 / 184
Uncut skins	

PERFORMANCE

The polyvalent Climb Pro Glide combines excellent gliding performance, good traction and utmost resistance. Extremely versatile use, ranging from competition to long-term touring.

QUALITY

Best gliding mix skin ever, best anti- glopping skins, very resistant: the skin for professionals.

APPAREL

100% bio cotton
Sizes available from XS to XL

ROUND NECK TEE-SHIRT



ROUND NECK SWEAT SHIRT



HOODIE



APPAREL

BEANIES



70gr, 100% acrylic
GREY BEANIE
Single size

70gr, 100% acrylic
ORANGE BEANIE
Single size

CAPS



56gr, 100% polyester
5 PANELS
Single size
Adjustable strap

80gr, coton
VELOURS CAP
Single size
Adjustable strap

83gr, organic cotton
CLASSIC CAP
Single size
Adjustable strap

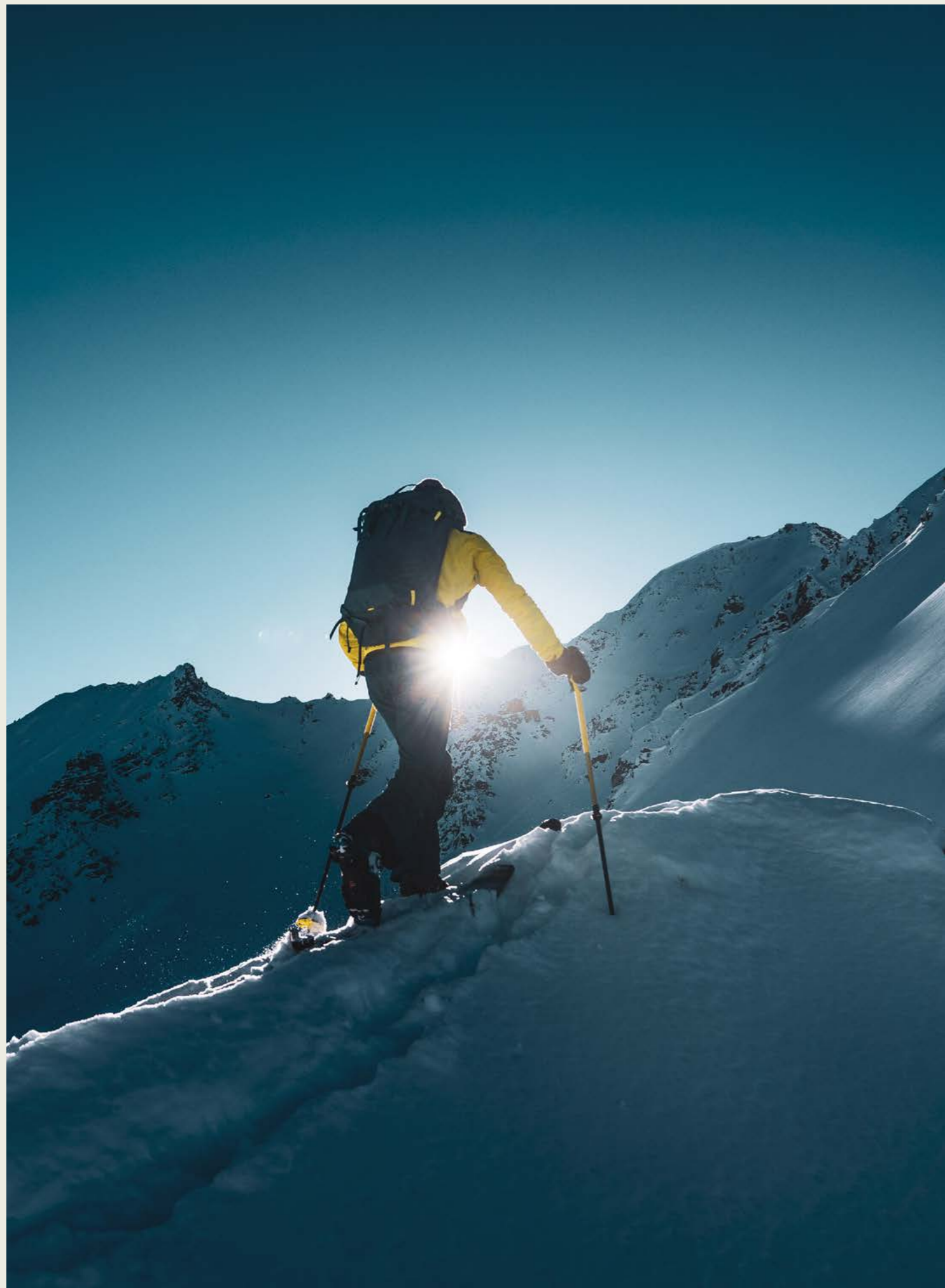

ORGANIZATION CHART

EXECUTIVE MANAGEMENT



CAROLINE DE WAILLY
CEO

SUPPLY CHAIN & FINANCE DEPARTMENT



ALIX AMELOOT
Finance &
HR Director



JULIETTE BARBIER
Administrative &
Accounting Assistant



FABIANA SERFATY
Supply Chain
Director

SALES DEPARTMENT



BAPTISTE BARBOT
Sales
Director

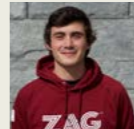

THOMAS CHABOT
France Sales
Manager



ALICE DOLIGEZ
Backoffice
Manager



CAMILLE PICHOT
Backoffice

R&D DEPARTMENT



BASTIEN SAILLARD
R&D Director



PAUL CHEVALLOT
R&D Assistant

MARKETING DEPARTMENT



ALAN LEMASSON
Digital Marketing
Manager



MARINE TESTOU
Promotion & Events
Manager



JÉRÔME BRULEY
Marketing Design
Manager

CONCEPT STORE DEPARTMENT



MATTHIS PARRA
Proshop ZAG
Manager

AGENTS & DISTRIBUTORS

ARGENTINA

DISTRIBUTOR - AVALANCHA

Lucas Rossini
rossiniacul@hotmail.com
+54 9 294 441 9927

AUSTRIA

AGENT - OUTDOOR AGENTUR UP

Sephan Mitter
stephanmitter@me.com
+43 664 221 5047

BULGARIA

DISTRIBUTOR - NOMADIA

Orlin
nomadia@abv.bg
+359 89 683 4018

BENELUX

AGENT - MINDSHAKE

Dimitri Papageorges
dimitri@mindshake.biz
+32 475 77 0570

CANADA

DISTRIBUTOR - COAST MOUNTAIN COLLECTIVE

Jens Ourom
team@coastmountaincollective.ca
+1 (604) 357 3987

CHILI

DISTRIBUTOR - HBD SPORT SPA

Christian Harrison
charrison@hbdtel.com
+56 9 90 89 83 57

CZECH/SLOVAQUIE

DISTRIBUTOR - HUDYSPOORT

Jakub Tausner
jakub.tausner@hudy.cz
+420 770 160 344

FRANCE

AGENT - SOUTH ALPES / ISÈRE

Simon Valle
simon@zagskis.com
+33 6 63 11 82 27

FRANCE

AGENT - PYRÉNÉES

Mathias Bertoux
mathias.bertoux@gmail.com
+33 6 09 87 15 46

FRANCE

AGENT - AUVERGNE - RHÔNE ALPES

Mick Midali
mick@zagskis.com
+33 6 89 17 60 08

GERMANY

AGENT - OUTDOOR AGENTUR UP

Christian Neiger
kontakt@outdoor-agentur-up.de
+49 179 49 38 391

GEORGIA

DISTRIBUTOR - MOGZAURI RENT

James Dean
james@mogzaurirent.ge
+995 568 65 99 85

ITALY

AGENT - OUT LAB DISTRIBUTION SRL

Luca cozza
luca.cozza@outlabdistribution.it
+39 347 898 6488

JAPAN

DISTRIBUTOR - STRANDS GEAR

Tadashi Sekine
tad@strandsgear.com

NEW-ZEALAND

AGENT - LITTLE DAHU LTD

Jeremy Serre
littledahu.nz@gmail.com
+64 2 116 945 76

NORWAY

DISTRIBUTOR - JBS SPORT

Jonas & Jorgen Stromquist
jonas@jbssport.no / jorgen@jbssport.no
+47 468 89 407 / +47 957 90 218

POLAND

DISTRIBUTOR - MALCZEWSKI SPORT

Marcin Malczewski
malczewskisport@gmail.com
+48 609 603 034

ROUMANIA

DISTRIBUTOR - FREESPORT

Laszlo
info@freesport.ro
+40 744 553 996

RUSSIA

DISTRIBUTOR - GRACHEV NIKOLAI

Grachev Nikolai
0135529@gmail.com

SWEDEN

AGENT - KLINGHEIM

Henrik Selander
henrik@klingheim.se
+46 70 915 18 50

SPAIN

DISTRIBUTOR - FREE4RIDE

Manolo copano / Guille Garcia
manolocopano@gmail.com
guillemgarcia@free4ride.es
+34 660 13 19 80
+34 636 87 00 66

SWITZERLAND

DISTRIBUTOR - NEW ROCK DISTRIBUTION

New Rock SA
info@newrocksport.ch
+41 91 935 14 00

USA

AGENT - GLOBAL SALES GUYS

West - Marty Carrigan
East - Sascha Dietschi Cooper
info@globalsalesguys.com
+1 970 977 7779
+1 415 350 4587

REST OF WORLD

INTERNATIONAL SALES MANAGER ZAG

Baptiste Barbot
baptiste@zagskis.com
+33 669 627 912

REST OF FRANCE

FRANCE SALES MANAGER ZAG

Thomas Chabot
thomas@zagskis.com
+33 785 802 236



+33 450 347 578
2100 Route d'Argentière
74400 Chamonix Mont-Blanc
FRANCE
info@zagskis.com

WWW.ZAGSKIS.COM

 @zagskis.com

**ELEVATE
YOUR SENSATIONS**



Pensez au recyclage - Catalogue imprimé sur du papier recyclé.
Think about recycling - Catalog printed on recycled paper.